

SOTERA[®]

820, 825, 850 Digital Meter

Installation and Operation Manual



MADE IN 
USA
WITH GLOBAL MATERIALS

GORMAN-RUPP
COMPANY

Table of Contents

About This Manual 3

Symbols and Definitions..... 3

General Description..... 3

Safety Instructions..... 3

Technical Information..... 4

Fluid Compatibility..... 4

Options..... 5

Installation..... 5

Operational Functions 6

Use..... 6

Calibration Using the CAL Factor 6

Calibration Procedure Using the CAL Factor..... 7

Batteries 8

Repair 8

Maintenance 8

Troubleshooting Guide..... 9

Meter Parts List..... 10

Appendix A 11

Appendix B – Water Calibration 12

Appendix C – Fluid Calibration (Other Than Water)..... 13

Appendix D – Flow Performance..... 14

CE Certification Information..... 14

Thank You!

Thank you for your loyalty to the Sotera® brand of chemical, lubricant, and mixed hydrocarbon transfer pumps. Your safety is important, so please read and thoroughly understand the procedures set forth in this manual. Protect yourself as well as those around you by observing all safety instructions and adhering to all danger, warning, and caution symbols. Please save these instructions for future reference and record the model, serial number, and purchase date of your Sotera digital meter. Please register your Sotera product via info.fillrite.com/sotera_product_registration.

IMPORTANT RETURN POLICY

Please do not return this product to the store. For all warranty and product questions, please contact Technical Support at 1 (800) 720-5192 or via email at SoteraTech@fillrite.com (M-F, 8 AM – 5 PM ET).





MODEL#	
SERIAL#	
PURCHASE DATE:	



About This Manual

From initial concept and design through final production, your Sotera product is built to provide years of trouble-free use. To ensure the safety of yourself and those around you, it is critical that this manual is read in its entirety prior to attempting to install or operate your new purchase. We strongly urge that any installer and operator become familiar with the terms, diagrams, and technical data in this manual and pay close attention to any DANGER, WARNING, CAUTION, or NOTICE information. At Sotera, your satisfaction with our products is paramount to us. If you have questions or need assistance with your product, please contact us at 1 (800) 720-5192 or via email at SoteraTech@fillrite.com (M-F, 8 AM – 5 PM ET).

Symbols and Definitions

 DANGER	Indicates a hazardous situation which, if not avoided, will result in death or serious injury.
 WARNING	Emphasizes an area in which personal injury or even death may result from failure to follow instructions properly. Mechanical damage may also occur.
 CAUTION	Failure to observe a "Caution" may cause damage to the equipment.
 NOTICE	These boxes contain information that illustrates a point that may save time, or be key to proper operation, or clarifies a step.

General Description

The Sotera 825 and 850 Meters are nutating disk, positive displacement meters that use magnetic coupling to convert fluid flow into digital display information. The meter can store and display the current flow amount (current total), or cumulative flow amount (totalizer) in any of five user specified units (ounces, pints, quarts, liters, and gallons) or special units (e.g. per acre volume). The meter can be calibrated without dispensing fluid simply by selecting a calibration factor from the 20 stored settings. Power is supplied by two AA field replaceable batteries. Pulsar models have the added ability to connect to fluid management systems for additional control and monitoring of fluid being dispensed.

Safety Instructions

 WARNING	<p>To ensure safe and efficient operation, it is essential to read and follow each of the following warnings and precautions.</p> <ol style="list-style-type: none"> 1. Agricultural herbicides flowing through the meter may be harmful to your health. Use and disposal of these products is controlled by federal, state, or local laws and procedures. 2. Conform to fluid manufacturer's recommended handling procedures when using product and when cleaning meter. 3. Do not exceed an internal meter pressure of 120 PSI/8.2 Bars. 4. Improper use or installation of this product can cause serious bodily injury or death. 5. The 825 & 850 Digital Meter is not for use with flammable fluids. DO NOT use with fluids with a flashpoint below 100°F (such as gasoline and alcohol). 6. DO NOT REMOVE PRINTED CIRCUIT BOARD! Damage to LCD could occur, and warranty is void.
--	---

Technical Information

Technical Information	
Flow ports	1" NPT inlet / outlet ports, female threads (3/4" BSPP also available)
Flow Range	2 to 20 U.S GPM / 7.6 to 75.7 LPM
Pressure	120 PSI / 8.2 Bar maximum @ 70°F / 21°C 50 psi / 3.4 Bars maximum @ 130°F / 54°C
Temperature	Min. operating temperature = 0°F / 17°C Max. operating temperature = 130°F / 54°C Meter can be stored at lower temperatures but display may not work below 0°F.
Accuracy	± 0.5%
Units of Measure	Ounces, pints, quarts, liters, gallons; special calibration option also available.
Range	9999 current total; 10,000,000 accumulated total

Materials of Construction	
Body	Polypropylene
Chamber	Polyphenylene sulfide (PPS) and 303 Stainless Steel
Wetted Seals	Fluorocarbon (EPDM optional)
Weather & Dust Body Seal	BUNA-N
Display	LCD (Liquid Crystal Display)
Power	Two CR2032 Lithium batteries and external 5 - 24 VDC (see page 8)

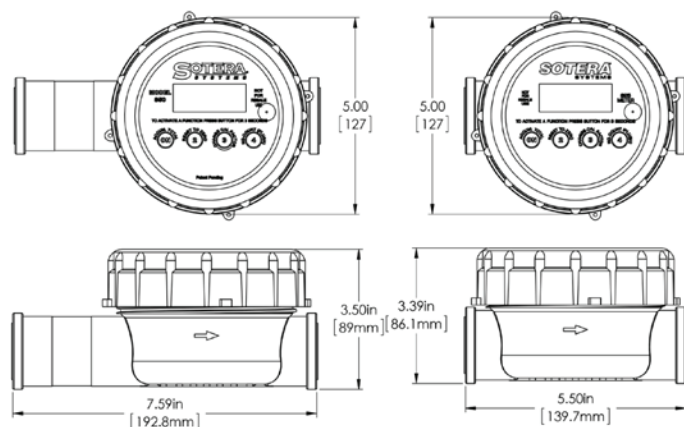

Fluid Compatibility

The 825 & 850 Digital Meters will handle most pesticides, automotive fluids (except gasoline), and mild acids. It is also compatible with the following fluids**:

- | | |
|--------------------|--------------------------------|
| Aatrex 4L® | Guardsman® |
| Abate 4E® | Harness xtra® |
| Apron® | Karate® |
| Agrotain® | Laddock S-12® |
| Assure II® | Lasso Micro Tech® |
| Atrazine 4L | *Lumax TM |
| Banvel® | Manifest™ |
| Banvel SFG® | Marksman® |
| Bicep® | Maxim® |
| Blazer® | Methyl Parathion Broadstrike®+ |
| Treflan® | Motor Oil Broadstrike®+ |
| Dual® | Nufos® |
| **Camix TM | Phosphoric Acid |
| Caustic Soda (50%) | Poast® |
| Clarity® | Poast HC® |
| Command® | 3ME Poast Plus® |
| Conclude® | Princep 4L® |
| Conclude®xtra | Prowl® |
| Contour | Detail™ |
| Diesel Fuel | Oil.Adend® |
| Doubleplay® | Dual® |
| Dual II® | Eptam 7E® |
| Ethylene Glycol | Fallowmaster® |
| Flexstar® | Frontier® |
| Fulltime® | Furadan® |
| Fusion® | Gramoxone Extra® |
| Gramoxone Inteon™ | Prowl® |
| 3.38EC Pursuit® | Reflex® |
| Rezult® | Ridomil Gold® |
| Roundup® | Sodium Hydroxide (50%) |
| Squadron® | Storm® |
| Surpass® | 100 Surpass® EC |
| Superboll® | Topnotch® |
| Touchdown® | Treflan™ |
| Treflan™ HFP | Water |

** Requires EPDM Seals.

Aatrex®, Aatrex® 4L, Bicep®, Bicep 11®, Dual®, and Dual 11® are registered trademarks of Syngenta Corporation. Broadstrike and Treflan are registered trademarks of Dow AgroSciences. Banvel®, BanvelSGF®, Blazer®, camix, Clarity®, Conclude®, Galaxy®, Guardsman®, Lumax, Manifest™, Marksman® Poast®, Poast HC®, Poast Plus®, Rezult®, and Storm® are registered trademarks of BASF. DoublePlay®, Eptam® 7E, FullTime, Fusion®, Gramoxone® Extra, Karate®, ReHex®, Surpass®, TopNotch, and Touchdown® are registered trademarks of Syngenta. Contour®, Detail, Pursuit®, Prowl®, and Squadron® are registered trademarks of American Cyanimid. Harness® Xtra, Roundup® are registered trademarks of Monsanto Company. Command®, and Furadan® are registered trademarks of FMC. Agrotain® is a registered trademark of IMCAgrico. Superboll® is a registered trademark of Griffin.

The 825P & 850P Digital Meters are NOT compatible with very strong acids or if fluid flash point is below 100°F (38°C). If in doubt about compatibility of a specific fluid, contact supplier of fluid to check for any adverse reactions to the following wetted materials:

Options

- EPDM Seals



Not for use with fluids that have a flash point below 100°F (37.8°C, ie: gasoline, alcohol). Refer to NFPA 325M (Fire Hazard Properties of Flammable Liquids, Gases, and Volatile Solids) for flash points of common liquids. Static electricity buildup and discharge could result in arc and explosion!



Installation

Use Teflon tape or thread compound on all threaded joints.

1. Determine direction for fluid flow and point arrow on meter body in that direction.
2. Thread hose or pipe into ports until snug. Be careful not to cross thread when starting threads.

Installation Hint

To prevent cross threading, turn the pipe / hose backwards (counterclockwise) until you feel it engage threads, then tighten.

Changing Meter Readout Position

If it is necessary to change position of the meter readout, follow these steps (Refer to exploded view).

1. Unscrew meter cap (item 1). Use a strap type oil filter wrench if too tight to unscrew by hand.
2. Insert a wide, flat-head screwdriver into the upper slot and gently pry up electronics module (see Figure 1).

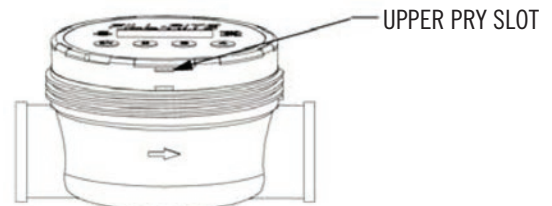

FIGURE 1

3. Gently rotate electronics module to desired location.

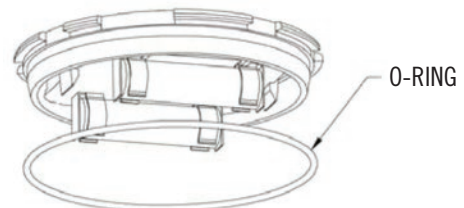

FIGURE 2

4. Press electronics module down into meter cover in the correct orientation.
5. Thread on meter cap until hand tight. To check tightness, there should be approximately 1/16" gap between the cap and ridge on outlet port (see Figure 3).

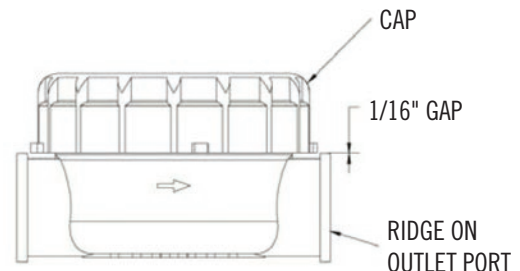

FIGURE 3

Operational Functions



- Turns meter on when off.
- Displays accumulated total as long as it is pressed. If accumulated total is larger than 9999, the numbers will scroll across the screen.



- When held for 3 seconds, it resets current total to zero. Also resets to normal operating mode when in CAL or FLSH mode.



- When held for 3 seconds, it allows changes to the calibration factor displayed in the bottom left corner. Repeated pressing will step the number up to 19 and back to zero. When desired number is displayed, press button 2 to lock in the new number and return to normal operation.



- When held for 3 seconds, flow rate is displayed. Fluid dispensed is still added to the accumulated total and current total. Press button 2 to return to normal operation.

Use



Meter will count air if you dispense air. Before initial operation or when air has entered the system, prime the meter by dispensing fluid until all trapped air has been removed. Meter is now ready to operate.

1. Press ON button to turn meter on. Current total, unit of measure, and calibration factor are displayed. The meter also turns on automatically and begins recording when fluid starts flowing through it.



2. Hold button 2 for one second to reset current total to "0.00."
3. Begin dispensing.

NOTE: Meter display automatically goes blank after 60 seconds of inactivity and automatically comes back on when flow resumes. No data is lost during periods of inactivity.



Wear proper safety equipment when handling hazardous fluids.

Calibration Using the CAL Factor

The **THINNER** the fluid, the **LOWER** the CAL number.

The **THICKER** the fluid, the **HIGHER** the CAL number.

- CAL 4 is set for thin fluids like water.
- CAL 19, the highest number, is set for very thick fluids like cold molasses.
- Each number changes the meter accuracy by about 1%.



CAL Factor

Table #1: Suggested CAL Factor Settings for Common Fluids

0	1	2	3	4	5	6	7	8	9	10	11	12	13	14	15	16	17	18	19
				Water		Kerosene		GRAMOXONE INTEON™ @ 50°F		Antifreeze @ 70° F		ROUNDUP® @ 50°F TREFLAN™ @ 50°F	ATRAZINE 4L @ 70°F	10W Oil @ 70°F	DUAL® @ 70°F		BICEP® @ 70°F		Molasses @ 32°F

NOTE: The suggested CAL factors are for REFERENCE ONLY.

Calibration Procedure Using the CAL Factor

Changing the CAL Factor

- Hold button ③ until the display only shows CAL and number.
- Press ③ repeatedly until you reach the desired number.
NOTE: Number will step up to 19, then back to zero.
- Press ② to return to normal operating mode.

Calibration Procedure

A) Set CAL factor to 10.

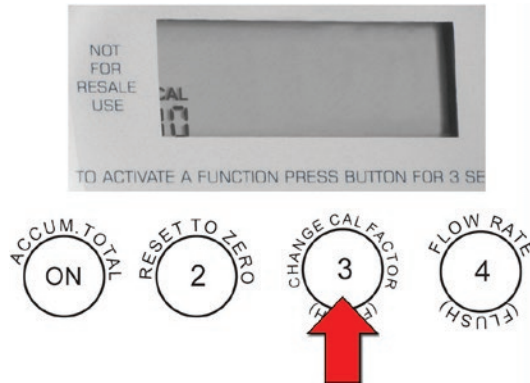

Hold button ③ for three seconds. Press ③ again until the number 10 shows below “CAL” (**NOTE:** If you go past 10 keep pressing ③ because the number will return to 0 after passing 19).

Press ② to get back to normal operating mode.

NOTE: If your fluid is listed on Table 1, use that number in step A above in place of 10.

B) Prime pump and meter by dispensing 2 - 3 gallons of fluid back into the bulk tank.

With the outlet valve closed and the pump still running, reset the meter to 0.00.

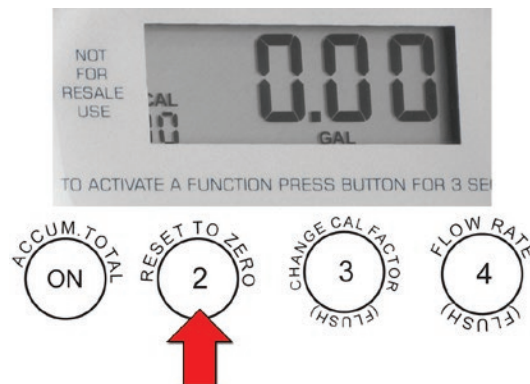

C) Fill the Proving Can exactly to the 5.0 gallon line.

Focus on the Proving Can, do not look at the meter at this point. Keep the hose end nozzle wide open as long as possible for best accuracy.

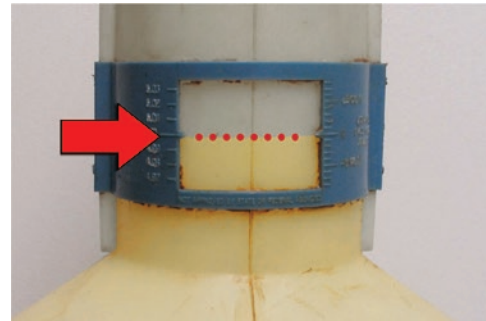

D) Adjust Meter CAL Factor.

- If meter reads high, increase the CAL factor. Each CAL # changes the accuracy by about 1%. For a 5 gallon proving can, 1% = 0.05 gallons.



- If 5.10 is displayed, this is 2% over 5.00; the CAL factor should be changed to CAL 12.



- If the meter reads low, lower the CAL factor. For example, if 4.90 is displayed, it is 2% less than 5.00, so the CAL factor should be set to 8.



- When finished with the CAL factor procedure, press ② to return to normal mode and to reset the meter to 0.00. The meter is now calibrated and ready to use.

Batteries

NOTE: Low battery icon will appear when batteries require replacement. Meter still functions properly for several days after the icon appears. Neither calibration, current total or totalizer quantities will be lost when you replace batteries.

To Replace Batteries (refer to exploded view).

1. Unscrew meter cap (item 1). Use a strap type oil filter wrench or large 5" jaw pipe wrench if needed.
2. Insert a flat-head screw driver into the top slot (see Figure 4) and gently pry up electronics module.



DO NOT get fluid or dirt in electronics area.

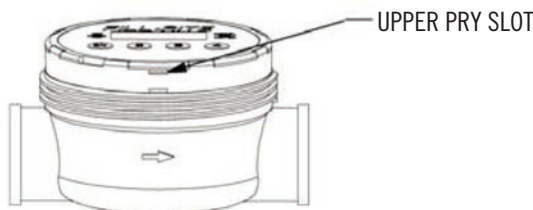

FIGURE 4

3. Remove old batteries and insert new batteries, making sure battery polarity is correct, or meter damage could occur.
4. As noted in Figure 5, reinstall O-ring on electronics module. Align sensor receptacle in proper location. Press module gently down into meter cover.

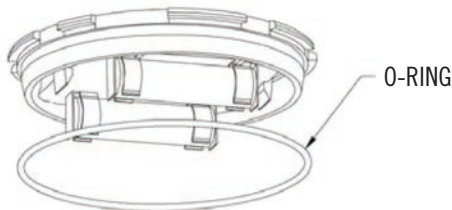

FIGURE 5

5. Thread on meter cap until hand tight. To check tightness, there should be approximately 1/16" gap between cap and ridge on outlet port. (See Figure 6).

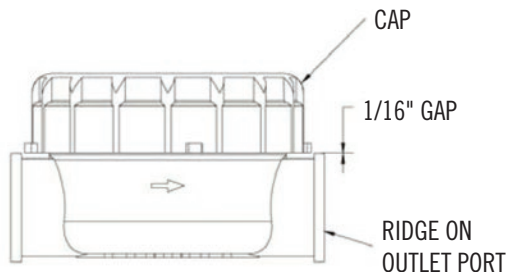

FIGURE 6

Repair

If any meter components are damaged, they should be replaced. See meter kits drawing on page 12 for correct replacement part information before ordering.

Maintenance



Follow fluid manufacturer's recommended procedures for handling and disposing of metered fluids.

Meter should be flushed between uses with water to prevent chemicals from drying and plugging meter.

Thorough Cleaning (refer to exploded view)

If meter is plugged due to hardened chemical or debris, do the following:

1. Drain all fluid from meter.
2. Unscrew meter cap (item 1). Use a strap type oil filter wrench or large 5" jaw pipe wrench if necessary.
3. Insert a flat-head screwdriver in the lower slot (see Figure 7) and turn to pry up meter cover (item 6).

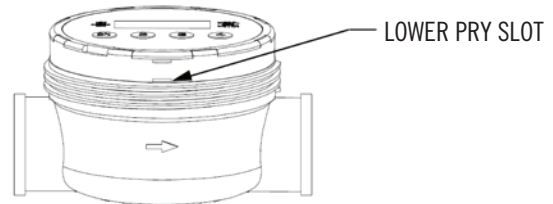

FIGURE 7

4. The meter chamber (item 8) can now be removed.
5. Rinse all meter components with flushing fluid. **DO NOT** submerge display assembly. **Be careful not to get any fluid or dirt in the electronics module.**
6. Reassemble meter.

CALIBRATION NOTE: Over time, the chamber inside the meter will wear, requiring the meter to be recalibrated with water. When this should be done depends on the amount and type of fluid dispensed. In most crop protection fluid uses (less than 1000 gallons of a clean fluid per year), the meter will remain accurate for many years without recalibration. On the other hand, dispensing an abrasive fluid may require more frequent recalibration.

The 825 / 850 meter is designed to be calibrated with clean water for safe handling. See "Water Calibration" section in Appendix B.

Storage

Store in a cool, dry place. Drain out all fluid that could freeze in the meter.

Troubleshooting Guide

Problem	Possible Cause	Solution	Notes
Meter won't turn on	<ul style="list-style-type: none"> Dead batteries Damaged or contaminated electronics module. 	<ul style="list-style-type: none"> Replace batteries. Replace electronics module & gaskets. 	Seal to electronic chamber is broken if display label is removed or punctured.
Flashing decimal	Current total has rolled over.	Reset display to zero by pressing button ②.	Meter will continue to operate normally.
Flashing or dim display	Low batteries.	Replace batteries.	Use CR2032 batteries.
Leaking fluid at inlet/outlet port	<ul style="list-style-type: none"> Need thread sealant. Cross-threaded port. 	<ul style="list-style-type: none"> Add Teflon pipe tape to joint. Replace body. 	
Fluid flows; meter won't count	<ul style="list-style-type: none"> Meter disk sticking. Damaged driver or magnet. Meter failure. 	<ul style="list-style-type: none"> Clean out meter chamber. Repair or replace chamber assembly. Repair or replace meter. 	
Meter reads high	<ul style="list-style-type: none"> Air in system. Wrong calibration factor. 	<ul style="list-style-type: none"> Prime system, fix suction leak at pump. Use a higher calibration factor. See 1-Step procedure. See "Check Meter" in Appendix A. 	Meter will count air. Chemical formulations sometimes change.
Meter reads low by 10% or less	Wrong calibration factor.	<ul style="list-style-type: none"> Use a lower calibration factor. See 1-Step procedure on page 7. 	Chemical formulations sometimes change. Temperature also affects accuracy.
Meter reads low by more than 10%	<ul style="list-style-type: none"> Meter chamber is worn. Chamber is partially plugged. Damaged or very worn chamber. 	<ul style="list-style-type: none"> Recalibrate meter with water. See Appendix B. See "Check Meter" in Appendix A. Clean chamber. Replace chamber and recalibrate meter. 	
Meter is not consistent	<ul style="list-style-type: none"> Air in system. Particulates in fluid. Worn or damaged meter chamber. 	<ul style="list-style-type: none"> Prime system, fix suction leak at pump. Put screen in front of meter. Clean chamber. Replace chamber. 	40 mesh minimum.
Err0	<ul style="list-style-type: none"> Calibration error. Damaged chamber. 	<ul style="list-style-type: none"> Recalibrate meter with a more accurate container. Replace chamber. 	Indicates fluid calibration is out of acceptable window. Volumetric container may be off, there may be air in the system, or the meter chamber may be damaged.
Err1	<ul style="list-style-type: none"> Damaged electronics. Software fault. 	<ul style="list-style-type: none"> Repair or replace electronics. Press ② then recalibrate meter 	Contact factory.
Err2	Bad eeprom.	Replace electronics.	Meter still functions, but all data will be lost if batteries are removed.

825 / 850 Meter Parts List		
Item #	Part #	Description
1	KITPOLYRING	Replacement Ring Kit
2	825G8559/850G8569	Replacement Electronics Kit 825/850
3	825KTF1582	Meter Chamber Kit and Seals

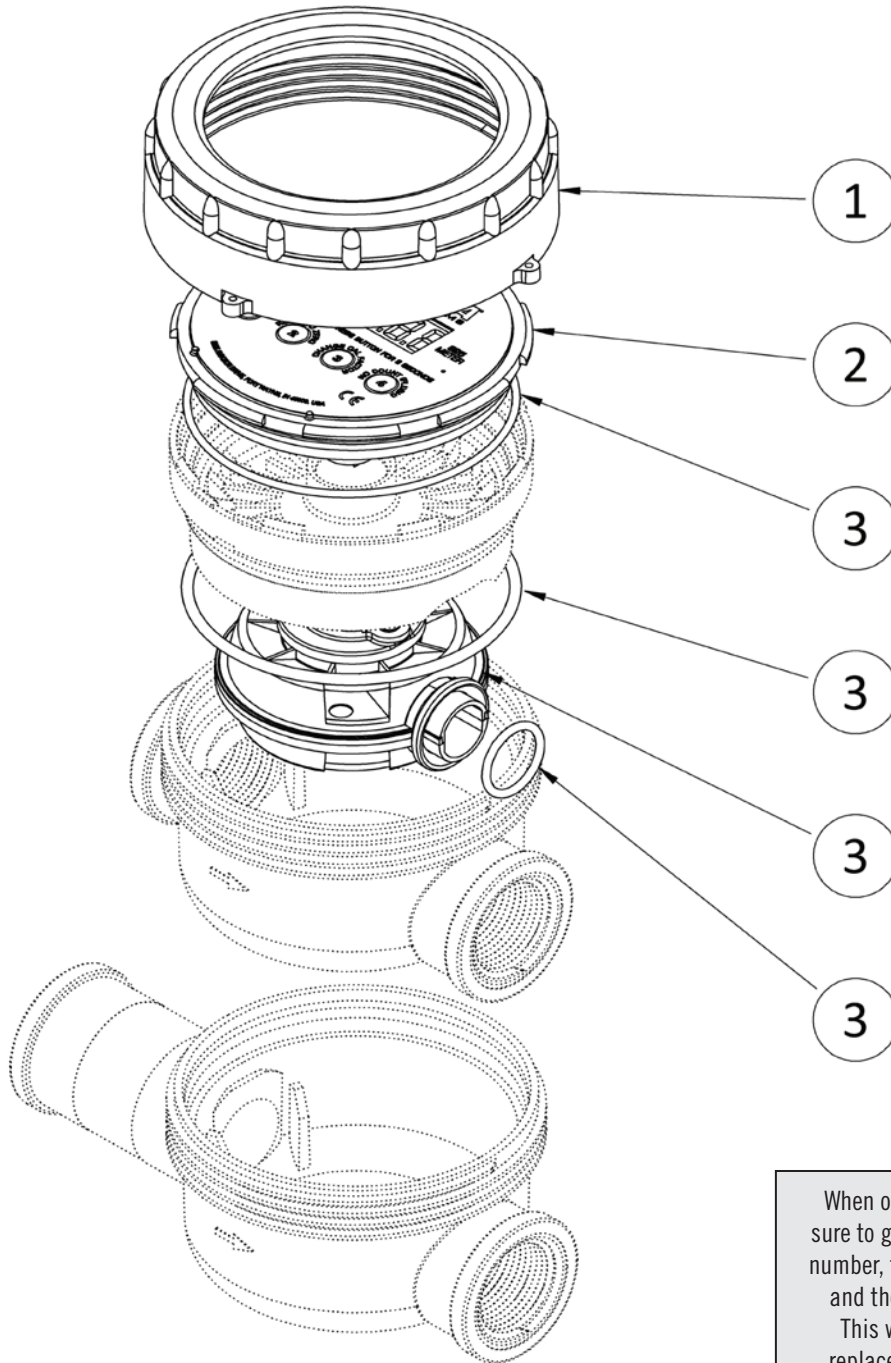

When ordering repair parts, be sure to give the replacement part number, the date of manufacture, and the meter series number. This will ensure the correct replacement part is supplied.

Technical Support:
(800) 720-5192

APPENDIX A

To Change Units of Measure

The units of measure can be changed to ounces (OZ), pints (PT), quarts (QT), gallons (GAL), or liters (LITER) without recalibrating the meter. If special units are desired, see note below.

1. Hold buttons ② and ④ for three seconds. Display will show current software revision level (i.e: r1.02).
2. Press button ③. Display will show the current units.
3. To change units, press the ON button repeatedly until the desired unit is displayed.
4. Press button ②. Display will show firmware revision.
5. To return to normal operating mode press button ② again.
6. The units selected will be displayed. Current or accumulated total will change to reflect the new units.

Special Units

To use special units, you need to know how many ounces are in your special unit. Here is an example: You want to use “acres” as your “special” unit. The fluid is to be applied at 18 ounces per acre. These are the additional steps to set the meter to “special” units (ignore steps 4 & 5 above):

1. After selecting “special” in step #3 above, press button ②.
2. Enter the number of ounces in a special unit by pressing button ④ to increment the digit, and the ON button to move the flashing digit to the right. If you make a mistake, press button ② to start back at the left most digit. Per our example, we would enter 018.0.
3. Press the ON button again. Current firmware will display.
4. To get back to the normal operating mode, press button ②.

Reset Accumulated Total

1. Press ② and ④ simultaneously and hold for 3 seconds.

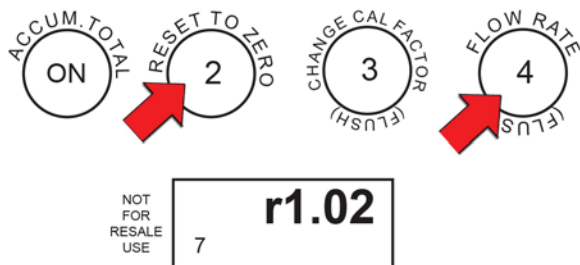

Display will read the version of the software loaded in the meter (example: “r1.02”).

2. Press ON to display accumulated total. If over 9999, display will scroll across the screen.

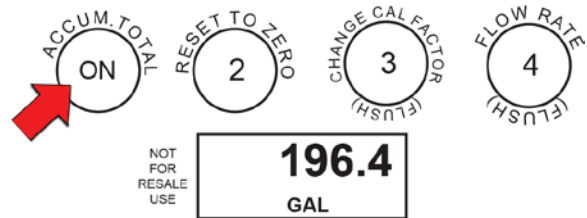

3. Hold buttons ON and ④ for 5 seconds to reset accumulated total.

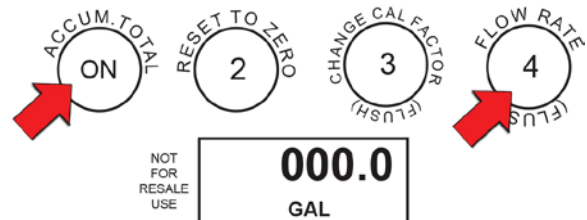

4. Press button ② twice to get back to normal operating mode.

Meter Check

You can check the calibration in your meter.

1. Set to CAL 4 (See “to change the calibration factor”).
2. Hold button ③ and ④ for 3 seconds. Meter will display “FLSH”.
3. Hold buttons ON & ③ together. A number will display that indicates the pulses per unit used to calculate flow (ie: pulses per gallon). When new, this number is between 120.0-127.0 pulses per gallon.

If you find a number higher than 127, recalibrate with water (see Appendix B). If this number is lower than 120, the meter chamber may need to be replaced.

4. Press ② to get back to normal operating mode.

FLSH (Flush) Mode

The 825/850 Meter can be flushed without adding to the totalizer. Turn meter on by pressing the ON button.

Press ③ and ④ simultaneously and hold for 3 seconds. Display will show FLSH. Flush meter with suitable fluid (water is suitable for most herbicides). When completed, press ② to leave FLSH mode and return to normal operation. Quantity of fluid flushed will not be added to total.

APPENDIX B – Water Calibration

The 825 / 850 meter is designed to be recalibrated with water for safe handling. Over time, the chamber inside the meter will wear. Recalibrating the meter with clean water will insure that Table #1 (calibration table page 6) is most accurate.

You will need a container of known volume, at least 5 gallons or larger. Do not exceed a 60 gallon container.

1. Press the ② & ④ buttons simultaneously and hold for 3 seconds.

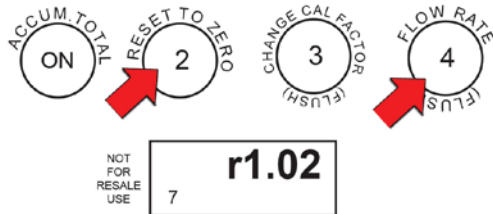

The display will read the version of the software loaded in the meter (example: “r1.02”).

2. Press button ③ to enter calibration mode.

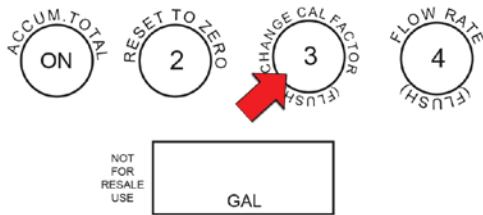

The unit of measure will be displayed.

3. Press button ③.

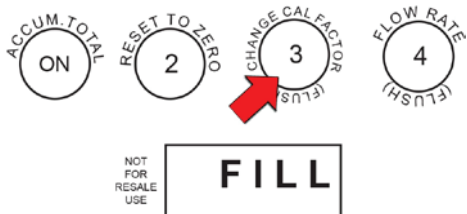

The display will read “FILL”.

4. Now dispense water into your container. “FILL” will flash on the display.
5. After dispensing, press the ON button.



The left digit of the display will blink.

6. Press the ④ button to increment the digit to the amount of fluid dispensed (example: **05.00**). Press the ON button to move to the right.



If you make a mistake, press button ② to start back at the left-most digit.

7. After number is loaded, press the ON button again to accept.

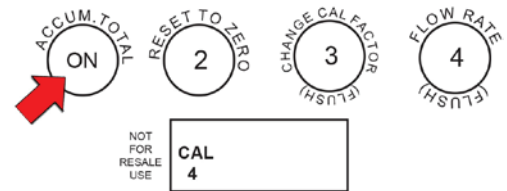

8. Display now shows CAL 4.

Since you are calibrating with water, accept this by pressing the ON button again. If calibrating with a fluid other than water, see Appendix C. Display will again show “r1.02”.

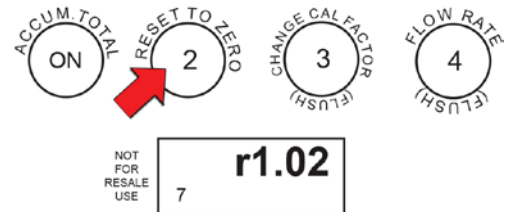

NOTE: If the value entered is out of an acceptable range, the display will read “Err0” and the meter will revert to the previous settings. See Troubleshooting Guide for more information.

9. Press ② to get back to the normal operating mode.

APPENDIX C - Fluid Calibration (Other Than Water)

CAUTION

DO NOT perform this calibration unless you fully understand how CAL factors work.

CAUTION

Calibrating with a fluid other than water voids Table #1 (calibration table page 6).
After calibration, set the meter to CAL 4, and use the meter on CAL 4 (unless you input a different number during step 9 below).

You will need a container of known volume, at least 5 gallons or larger. Do not exceed a 60 gallon container.

1. Press the ② & ④ buttons at the same time and hold for 3 seconds.

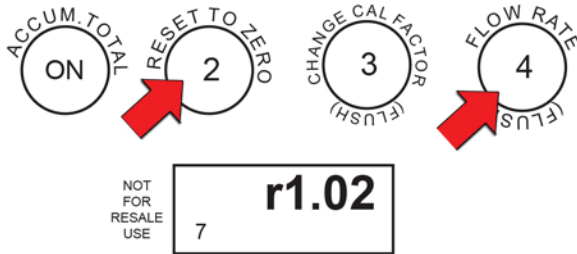

The display will read the version of the software loaded in the meter (example: "r1.02").

2. Press button ③ to enter calibration mode.

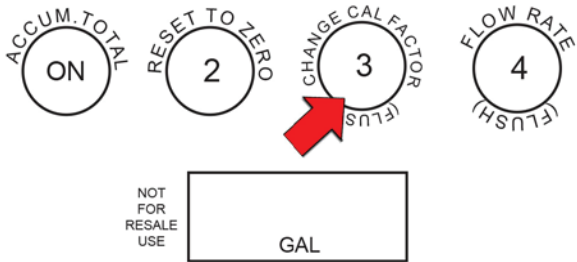

The unit of measure will be displayed.

3. Press the (ON) button to change unit of measure, if required. This is ONLY necessary if calibrating a different unit of measure.
4. Press button ③.

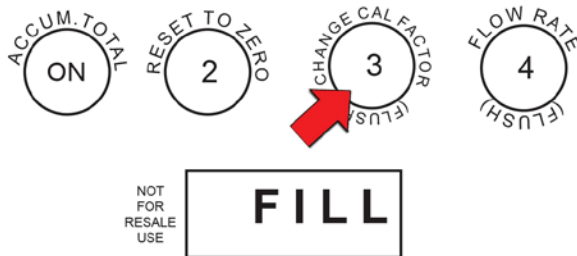

The display will read "FILL".

5. Now dispense fluid into your container. "FILL" will flash on the display. For best results, dispense fluid at the same flow rate that will be used in actual use.
6. After dispensing, press the (ON) button.

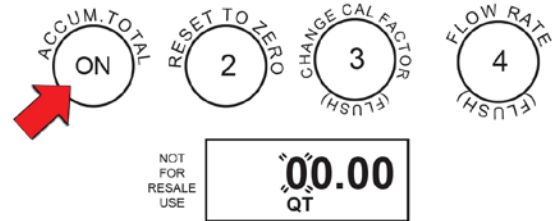

The left digit of the display will blink.

7. Press the ④ button to increment the digit to the amount of fluid dispensed (example: 05.00).

Press the (ON) button to move to the right.



If you make a mistake, press button ② to start back at the left-most digit.

8. After number is loaded, press (ON) button again to accept.

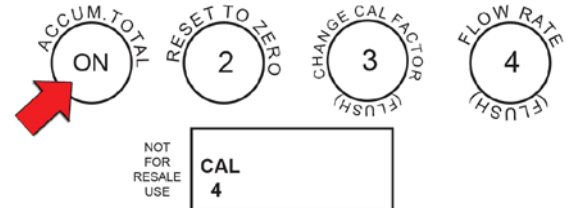

9. Display now shows CAL 4.

This is the default for water. Check Table 1 for your fluid. Press ③ to change the Cal #. Press (ON) to accept. Display will again Show "r1.02".

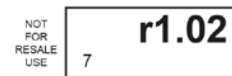

NOTE: IF YOU ACCEPT CAL 4, USE THE METER ON CAL 4 WHEN DISPENSING THIS FLUID.

NOTE: If the value entered is out of an acceptable range, the display will read "Err0" and the meter will revert to the previous settings. See Troubleshooting Guide for more information.

10. Press ② to get back to the normal operating mode.

APPENDIX D – Flow Performance

METER CALIBRATION FACTOR SELECTION BASED ON FLUID VISCOSITY

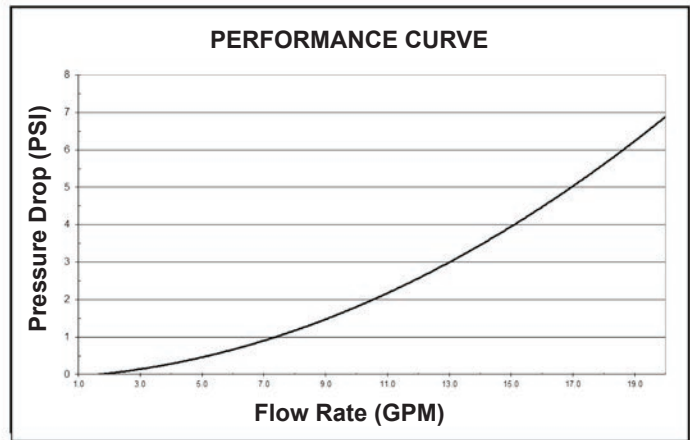
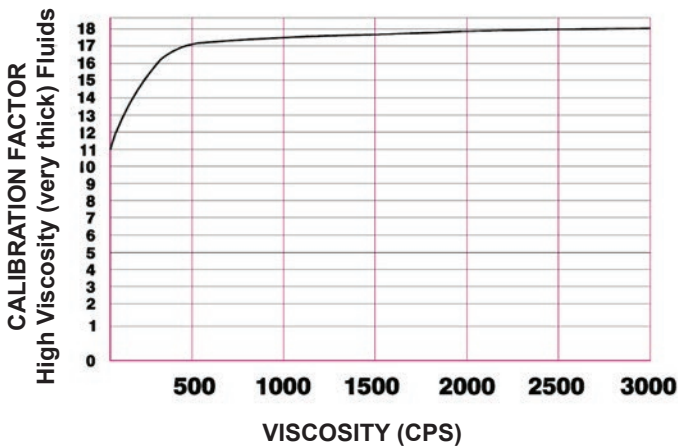
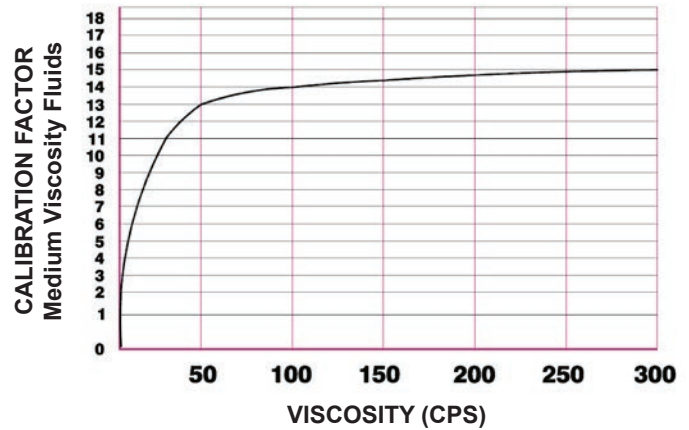
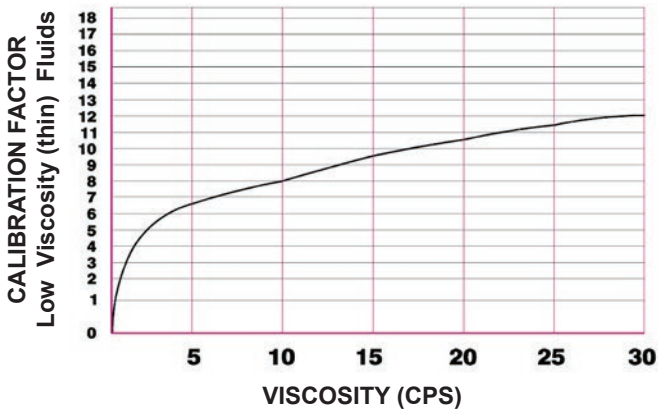

NOTE: Graphs are accurate with original factory calibration, or a water calibration.

CE Certification Information

The 820, 825 and 850 meters bearing the CE mark have been certified to the following European directives:

- 2011/65/EU: Restriction of the use of certain hazardous substances in electrical and electronic equipment.
- 2004/108/EC: Electromagnetic Compatibility

The following standards were used to test and show compliance:

Emissions

EN 55011:2009/A1:2010 Group 1, Class B, Industrial, Scientific, and Medical (ISM) Equipment

Immunity

- EN 61326-1:2006, Electrical Equipment for Measurement, Control and Laboratory Use
- IEC 61000-4-2: ESD
- IEC 61000-4-3: Radiated Immunity
- IEC 61000-4-8: Magnetic Field

This page has been intentionally left blank.

SOTERA[®]

Fill-Rite Company
8825 Aviation Drive
Fort Wayne, Indiana 46809 USA
T 1 (800) 720-5192
1 (260) 747-7524
F 1 (800) 866-4681



fillrite.com | sotera.com | gormanrupp.com