

TANK FILLING SYSTEM

462F4501



Software rel. 1.x

INSTALLATION, USE AND MAINTENANCE

LEGEND SYMBOL



= **Generic danger**



= **Warning**

This manual is an integral part of the equipment to which it refers and must accompany the equipment in case of sale or change of ownership. Keep it for future reference; ARAG reserves the right to modify the specifications and instructions regarding the product at any time and without prior notice.

1	SAFETY GUIDELINES	4
2	PRODUCT DESCRIPTION	4
2.1	Intended use	4
3	INSTALLATION	5
3.1	Electric connections.....	6
3.2	Hydraulic connections	7
3.2.1	<i>General warnings</i>	7
3.2.2	<i>Hydraulic connections</i>	7
3.3	Connections - general diagram.....	7
3.4	Monitor rotation.....	8
4	CONTROLS IN THE MENU	9
4.1	First switch on	9
5	MENU STRUCTURE	10
6	PRELIMINARY SETUP FOR USE	11
6.1	Operating mode selection (FILLING / FLOWRATE)	11
7	USE IN FILLING MODE	11
7.1	Preliminary setup.....	11
7.1.1	<i>Valve activation time</i>	11
7.2	Flowmeter use (FILLING mode).....	12
8	USE IN FLOWRATE MODE	13
8.1	Flowmeter use (FLOWRATE mode)	13
8.2	Partial totalizer reset.....	13
9	OTHER SETTINGS	14
9.1	Calibration.....	14
9.1.1	<i>Automatic calibration</i>	14
9.1.2	<i>Manual calibration</i>	15
9.2	Flowrate alarms	15
9.3	Display.....	16
9.4	Options.....	16
9.4.1	<i>Language</i>	16
9.4.2	<i>Units of measurement</i>	17
9.4.2.1	<i>Rate units of measurement</i>	17
9.4.2.2	<i>Volume units of measurement</i>	17
9.5	Test	18
9.5.1	<i>Display test</i>	18
9.5.2	<i>Keys test</i>	18
10	MAINTENANCE	19
10.1	Notes on maintenance	19
10.2	Paddle cleaning and replacement.....	19
10.3	OR replacement	20
10.4	Troubleshooting	21
11	TECHNICAL DATA	22
12	DISPOSAL AT THE END OF SERVICE	23
13	GUARANTEE TERMS	26

1 SAFETY GUIDELINES

CARRYING OUT INSTALLATION AND MAINTENANCE OPERATIONS WITHOUT DISCONNECTING THE VALVE FROM ITS POWER SUPPLY MAY CAUSE SEVERE INJURY.

Do not operate the valve with no load for long periods of time, as this might damage the components inside the valve.

ARAG can not be held responsible for direct or indirect damage caused by the type of fluids used for spraying and crop spraying applications.

These products are used under the exclusive responsibility of the operator, who must make sure that all safety prescriptions indicated on the product label are complied with and that suitable personal protective equipment (such as gloves, overalls, boots, helmet, etc.) is worn at all times in compliance with the applicable legal requirements.

The tank filling system can detect the passage of conductive fluids with a conductivity equal to or higher than 300 $\mu\text{S}/\text{cm}$.

- Do not place the equipment under pressurized water.
- Comply with the specified power voltage (12 Vdc).
- If arc welding is needed, make sure that the power supply to the tank filling system is disconnected; if necessary disconnect power cables.
- Use the tank filling system only within recommended rate range (Tab. 1, Pag. 13). Outside this range, the tank filling system may provide incorrect data, thus misleading the operator or the automatic system.

ARAG can not be held responsible for damage caused to persons, animals or things from the incorrect or unintended use of the tank filling system or its parts.

2 PRODUCT DESCRIPTION



The movable tank filling system measures and displays on its screen a pre-established quantity of fluid and stops tank filling when the set quantity is reached. Through electromagnetic measurement, the tank filling system (which features no moving mechanical parts) emits a signal that is proportional to the flow of fluid passing through it. The flowmeter displays the relevant flowrate, which is calculated according to the impulses generated and the value of the flowmeter constant previously set.



2.1 Intended use

This device is designed for agricultural use. The machine is designed and built in compliance with EN ISO 14982 standard (Electromagnetic compatibility - Forestry and farming machines), harmonized with 2014/30/EU Directive and in compliance with 2006/42/EC Directive.

The tank filling system must not be used to measure the passage of hydrocarbons, flammable, explosive or toxic liquids. The tank filling system is not suitable for contact with liquids for human consumption. Use for sales transactions is not allowed.

3 INSTALLATION

The tank filling system must be connected by means of suitable fittings (With female fork coupling) to a pump, which will supply the liquid to be poured into the tank.

Install the tank filling system at least 20 cm from the elements that could cause turbulence inside the tubes (valves, bends, constrictions, etc.).



WARNING:

- Rest the tank filling system on a horizontal surface
- The system to which it is connected must have a filtering element with a filter of at least 50 mesh, together with a safety valve to limit use pressure at the specified max. value (12 bar).



CAUTION:

ARAG is not liable for damage to the system, persons, animals or things caused by the use of material other than specified.

Failure to observe the above instructions automatically voids the warranty.

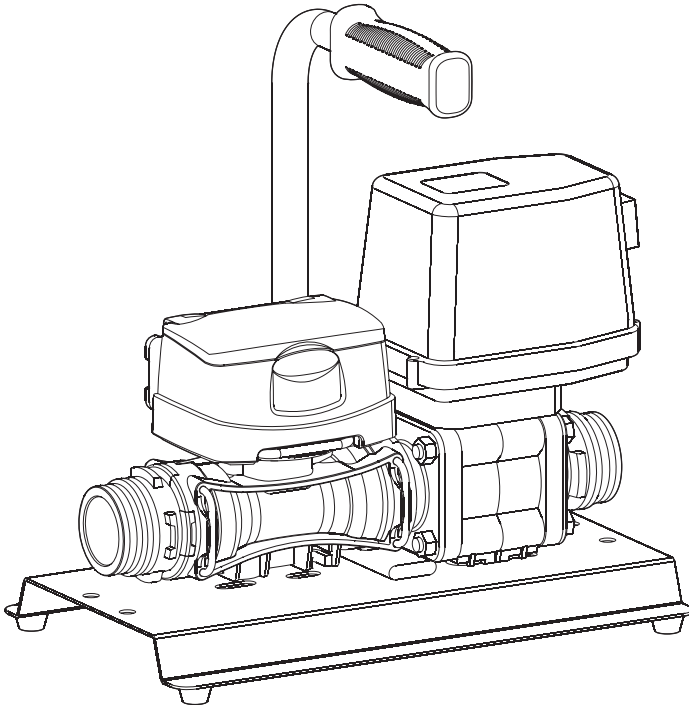

INSTALLATION

3.1 Electric connections

The tank filling system must be connected using the supplied cables.

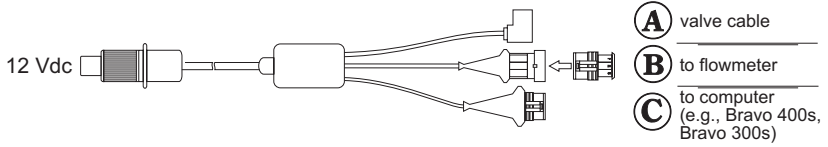
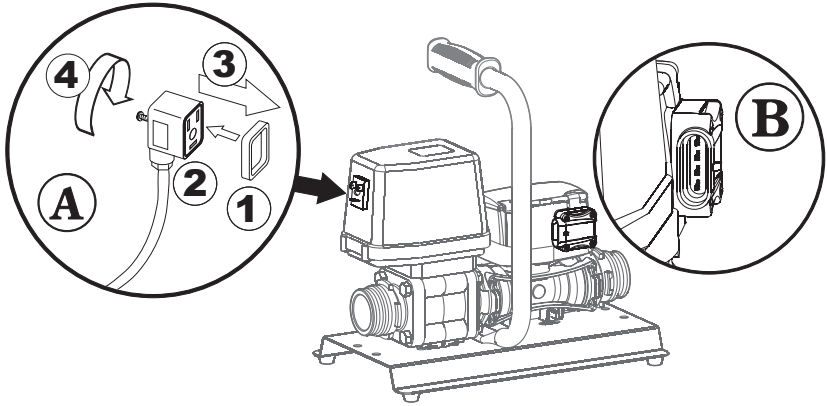

- Remove the protection cap from the valve
- Position seal (1 in Fig. A) onto connector (2 in Fig. A), then connect the latter pressing it fully home (3 in Fig. A). During this operation, take special care not to bend valve electric contacts.
- Fasten screw (4 in Fig. A) until it is tightened.



CAUTION: If the gasket is not positioned correctly, there may be infiltrations of water in the connector and in the valve, with the consequent risk of damage to the device.

DO NOT CONNECT THE POWER SUPPLY USING DIRECT FASTON CONNECTORS.

Bravo connector (C) - Connections:

Cable colour	Position	Connection	
Grey	1	GND	
Brown	2	+12 VDC	
Yellow/Green	3	Signal (square wave)	
Black	4	Pump control	

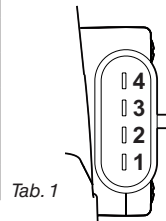

3.2 Hydraulic connections

3.2.1 General warnings

Avoid bends and constrictions before connections and on tubes.

Do not use the tank filling system with pressure values over 12 bar.

Regarding connections, use tubes and fittings properly sized for the operating pressure of the system.

Use Arag T6 fittings (see general catalogue) with female fork coupling. Do not use elbow fittings.



WARNING: For the implementation on already operating systems it is necessary to follow all safety rules described herein. System assembly and start-up must be carried out by expert personnel according to the safety rules so as to ensure the same safety level of the system.

3.2.2 Hydraulic connections

Connect inlet pipes to the valve and outlet pipes from the flowmeter, using suitable connectors. Take special care, where requested, to insert the O-ring correctly. If, for any reason, the pipes leak at connection points, apply unsintered PTFE tape to improve sealing.

3.3 Connections - general diagram

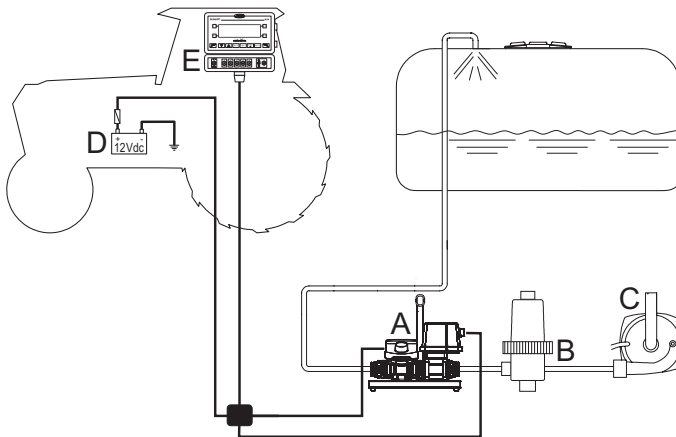

Legend:

- A** Tank filling system
- B** Filter
- C** Tank filling pump
- D** Battery
- E** Computer (e.g., Bravo 400s)

INSTALLATION

3.4 Monitor rotation

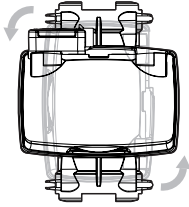

In case of vertical assembly, to simplify the use of the DigiWolf it is possible to rotate the monitor by 90° with respect to the body.

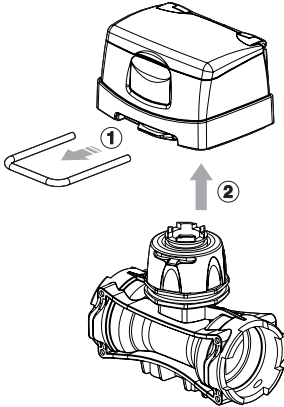

- 1) Remove the fork from the monitor using a screwdriver.
- 2) Remove the monitor from the flowmeter body.



If the monitor is turned upside down, the letters **A** and **B** can be seen: these correspond to the two possible monitor positions (parallel and perpendicular to the body).

DigiWolf is supplied with the sensor in position **A** (parallel to the body).



With the aid of a screwdriver, loosen the screw locking the sensor **without removing it**.





Rotate the sensor anti-clockwise until reaching **B** stop position.

Tighten back the screw **without forcing it**. The monitor is ready to be fitted in perpendicular position to the body.

Fit the monitor back on the flowmeter body.

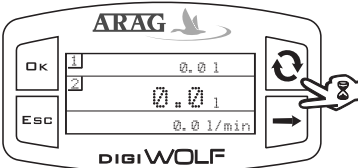
4 CONTROLS IN THE MENU

	<p>SWITCH ON</p> <p>The flowmeter is turned on when powered.</p> <p>Press the key to see the succession of different values written in full (central part of the display).</p> <p>Whenever the device is switched on, it will briefly display its name and software version.</p>
	<p>ACCESS TO SETUP MENU</p> <p>Press the keys for 2 seconds at the same time to access setup menu.</p>
	<p>SELECTION AND ACCESS TO MENU ITEMS</p> <p>A Press in succession to move through items (the selected item is highlighted with a black band)</p> <p>B Press to access the selected item</p> <p>Three dots under an item show the presence of another setup menu.</p>
	<p>MODIFYING DATA</p> <p>A Press to toggle from one digit to another</p> <p>B Press in succession to modify the value of the digit highlighted by the cursor</p> <p>C Press to confirm the change. The display goes back to the previous screen.</p> <p>D Press to exit current page without confirming changes.</p>

4.1 First switch on



At first switch on, DigiWolf will run a guided procedure to set the language, two units of measurement (flowrate and volume), and the operating mode (filling or flowrate).

Press  key to move between items, **OK** to save and move to the next setting, or **ESC** return to the previous setting.

5 MENU STRUCTURE

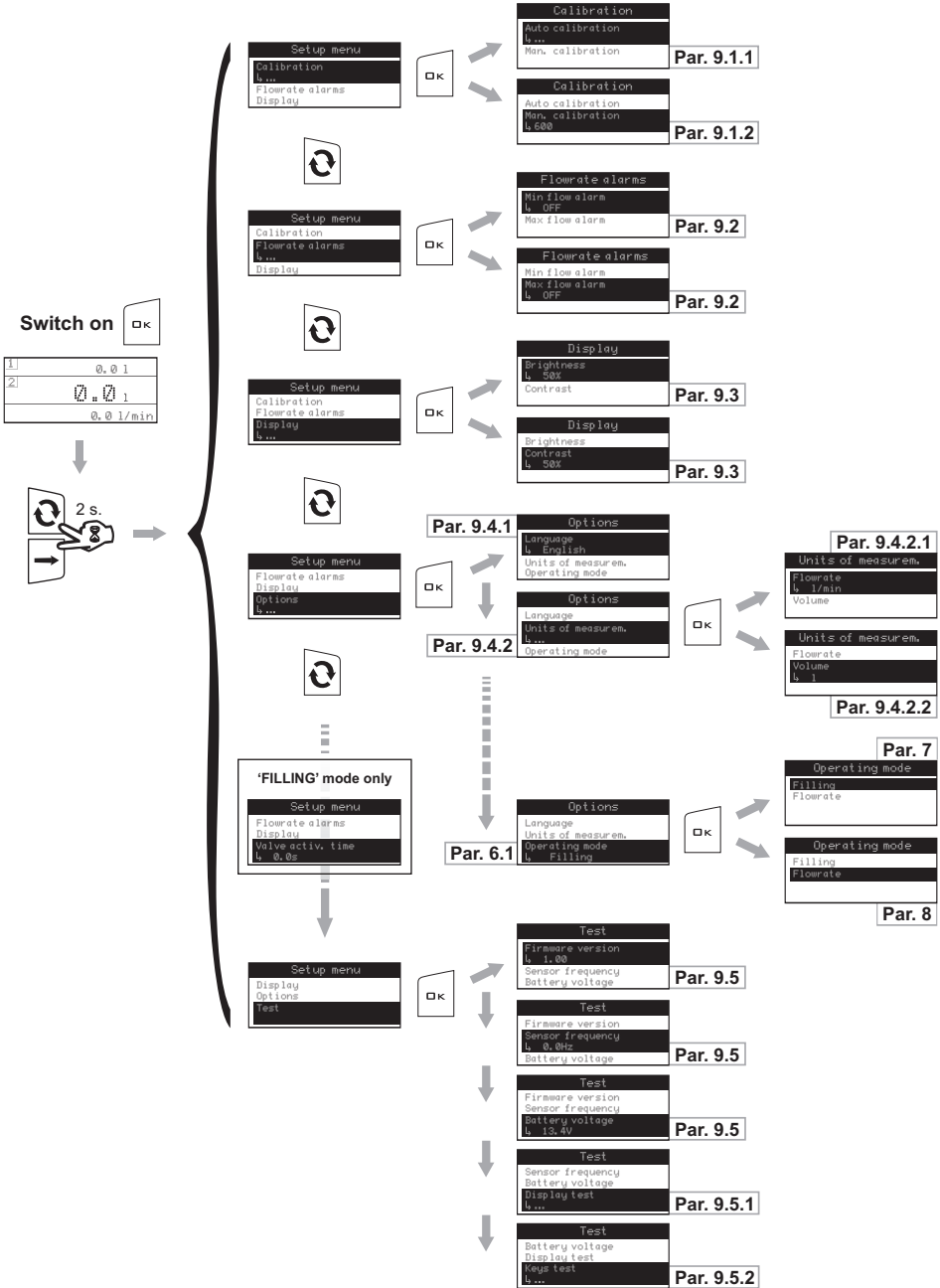

6 PRELIMINARY SETUP FOR USE

For a correct display of data regarding treatment, some preliminary set ups are necessary when installing DigiWolf on farming machines.

6.1 Operating mode selection (FILLING / FLOWRATE)

DigiWolf can be used to measure the flowrate of a fluid in a hydraulic circuit ("Flowrate" mode), or to control the filling of a tank by stopping the introduction of liquid once the set quantity has been reached ("Filling" mode).



Some menu items will be available or not according to the set mode.

	<p>1) Go to the operating mode selection menu (Setup menu > Options > Operating mode).</p> <p>Under the selected item, the currently set mode will be displayed.</p>
	<p>1) Select the desired operating mode with the key.</p> <p>2) Press OK to save, or ESC to exit without saving.</p>

7 USE IN FILLING MODE

7.1 Preliminary setup

7.1.1 Valve activation time

It is possible to set the filling valve activation time, i.e. the time interval between the sending of valve closure signal and the flow actual interruption, so that DigiWolf can calculate the exact time of operation and therefore the quantity introduced.









The value to be entered is indicated in the technical sheet of the filling valve installed in the system.

	<p>1) Access the valve activation time menu (Setup menu > Valve activ. time).</p> <p>Under the selected item, the currently set value will be displayed.</p>
	<p>2) Use the relevant keys to set the valve activation time:</p> <p>A) Press to toggle from one digit to another</p> <p>B) Press in succession to modify the value of the digit highlighted by the cursor</p> <p>C) Press to save changes or D) Press to exit current page without confirming changes.</p>

USE (FILLING MODE)

7.2 Flowmeter use (FILLING mode)

The main screen shows the display divided into three horizontal sectors:

	<p>- upper sector: The Start item refers to the key on the side, which allows starting the procedure (OK key);</p> <p>- central sector: the value represents the set filling quantity (in liters). Next to it appears the symbol Φ;</p> <p>- lower sector: The Quantity item refers to the key on the side, which allows setting the value of tank filling (ESC key).</p>
	<p>1) Keep ESC key pressed for two seconds to access the filling quantity set up menu.</p>
	<p>2) Using the suitable keys, set the filling quantity value:</p> <p>A) Press to toggle from one digit to another B) Press in succession to modify the value of the digit highlighted by the cursor C) Press to save changes or D) Press to exit current page without confirming changes.</p>
	<p>3) Keep OK key pressed for two seconds. The filling process starts.</p>
	<p>The display shows the following data:</p> <ul style="list-style-type: none"> - upper sector: set filling quantity; - central sector: partial totalizer; - lower sector: instant rate. <p>To see a datum in full, press the button several times until the desired value is in the central sector of the display.</p> <p> Displayed data can not be edited.</p>
	<p>The tank filling can be interrupted at any time by pressing ESC key. The Pause message will appear in the lower part of the display.</p> <p>Press OK key to restart the filling process;</p> <p>Press ESC key to definitively stop the filling; the display will go back to the main page.</p>
	<p>The filling stops automatically once the set quantity is reached.</p> <p>The Completed message will appear in the lower part of the display.</p>



8 USE IN FLOWRATE MODE

8.1 Flowmeter use (FLOWRATE mode)

The main screen shows the display divided into three horizontal sectors.

The sectors showing the symbols **1** and **2** represent the partial totalizers, individually resettable.

The third data represents instant rate value.

 <p>Partial totalizers</p> <p>Instantaneous rate</p>	
	<p>Feed some liquid to the system. The display will start to show the increasing value of the measured quantity of liquid, and the instant rate value.</p>

8.2 Partial totalizer reset

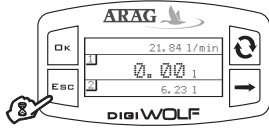
	<p>To reset a totalizer, it is necessary to visualize it in full.</p> <p>To do this, press the button several times until the value to zero in the central area of the display.</p>
	<p>Press ESC key for two seconds. The totalizer will zero.</p>

- Do not place DigiWolf under pressurized water.

- Use the flowmeter only within recommended rate range (Tab. 2 - Pag. 22). Beyond these limits, the flow-meter may give out incorrect data.

-To avoid damaging the flowmeter, do not exceed the maximum rate except for short periods.



ARAG can not be held responsible for damage caused to persons, animals or things from the incorrect or unintended use of Digiwolf or its parts.

- Do not exceed the max. operation pressure (12 bar).



Display of the symbol shows that the rate or the totalizer are over the max. displayable value.

Totalizers have floating points and display a max. of 5 figures. Up to 999.99 two decimals are shown, it then drops to 1 and 0 with the transition to thousands and tens of thousands (See fig. below).

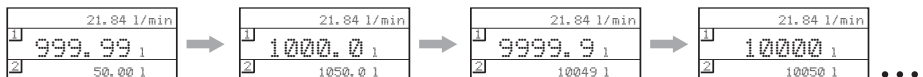

9 OTHER SETTINGS



What follows applies to both operating modes of the flowmeter.

9.1 Calibration



Rate reading may not be correct due to different system configurations (tubes, valve, etc.). Therefore, we recommend to make a spray test; in case the measured value is different from the real one, perform an automatic calibration procedure or manually calculate flowrate constant.

9.1.1 Automatic calibration

Make a quantity of liquid previously measured or that can be measured with another system go through the flowmeter. **The greater the amount of liquid used to perform the calibration procedure, the more accurate the calibration.**

	<p>1) Access Automatic calibration menu (Setup menu > Calibration > Auto calibration). Once inside the menu, the device is ready to start measuring without any further controls.</p>
	<p>2) Make the liquid go through the system. The display will start to show the increasing value of the measured quantity of liquid. Once liquid passage has finished, the value on the display will not change any more. At this point, press OK. In the lower part of the display, the message Stabilization will come up and the device will show the screen on the side.</p> <p>① Setting of liquid amount actually passed through the flowmeter during calibration procedure. ② Display of liquid amount read by the flowmeter during calibration procedure.</p>

3) Using the keys, enter the values of the liquid quantity previously measured:

- A) Press to toggle from one digit to another
- B) Press in succession to modify the value of the digit highlighted by the cursor
- C) Press to complete calibration procedure, or D) Press for 1 sec. to cancel calibration procedure.

If, after starting calibration, the device does not sense any flow passage (and the display remains in 0), press **OK to exit the calibration procedure without saving.**







If the device continues to sense the liquid flow after pressing **OK, after a few seconds the error message **Stop flow!** will be displayed.**

Once the flow has been interrupted, the reading will stabilize as by standard procedure.

9.1.2 Manual calibration



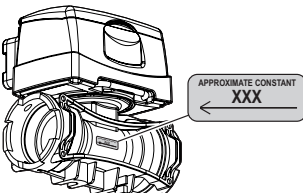

 To set the flowrate constant manually, calculate and set the correct constant using the following formula:

$$\frac{\text{[amount measured by device]}}{\text{[actually delivered quantity]}} \times \text{[constant indicated on flowmeter body]}$$

	<p>1) Access Manual calibration menu (Setup menu > Calibration > Man. calibration).</p> <p>In Calibration menu, selecting Manual calibration, under the item the currently set constant will be displayed.</p> <p>Press OK key to access value modification.</p>								
	<p>2) Using the suitable keys, set the value of the flowmeter constant:</p> <p>A) Press to toggle from one digit to another</p> <p>B) Press in succession to modify the value of the digit highlighted by the cursor</p> <p>C) Press to save changes or D) Press to exit current page without confirming changes. Refer to the label on the body</p>								
	<p> The flowmeter body must be assembled with the arrow on the label facing the flow direction.</p> <table border="1" data-bbox="554 707 938 834"> <thead> <tr> <th>CODE</th> <th>Approximate constant</th> </tr> </thead> <tbody> <tr> <td>4627405A</td> <td>250</td> </tr> <tr> <td>4627506A</td> <td>132</td> </tr> <tr> <td>4627707A</td> <td>64</td> </tr> </tbody> </table>	CODE	Approximate constant	4627405A	250	4627506A	132	4627707A	64
CODE	Approximate constant								
4627405A	250								
4627506A	132								
4627707A	64								

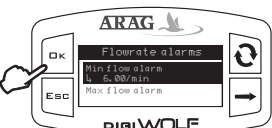
9.2 Flowrate alarms





Set the minimum and maximum values beyond which the display must show an alarm message.

	<p>1) Access Flowrate alarms menu (Setup menu > Flowrate alarms).</p> <p> Min. and max. flowrate alarms setting is done in the same way.</p> <p>Under the selected item, the currently set value will be displayed.</p> <p>Press OK key to access modification of the selected item.</p>
	<p>2) To activate the alarm, press OK and RIGHT keys at the same time until the message OFF disappears and flowrate alarm value is displayed.</p> <p>Carry out the same procedure to deactivate flowrate alarm again.</p>
	<p>3) Set flowrate alarm value:</p> <p>A) Press to toggle from one digit to another</p> <p>B) Press in succession to modify the value of the digit highlighted by the cursor</p> <p>C) Press to save changes of D) Press to exit current page without confirming changes.</p>

SETUP

9.3 Display



Adjust display brightness and contrast.

	<p>Access display menu (Setup menu > Display).</p> <p> Brightness and contrast adjustment is done in the same way.</p> <p>Under the selected item, the currently set value will be displayed.</p> <p>Press OK key to access modification of the selected item.</p>
	<ol style="list-style-type: none">1) Set the value using the  key. Each time it is pressed, the value will increase by 10% until reaching 100% and then starts back from 0.2) Press the OK key to save, or ESC to exit without saving.

9.4 Options

9.4.1 Language



Set desired language and units of measurement.

	<p>Access language setup menu (Setup menu > Options > Language).</p> <p>Under the selected item, the currently set value will be displayed.</p> <p>Press OK key to access language selection.</p>
	<ol style="list-style-type: none">1) Select language using the  key.2) Press the OK key to save, or ESC to exit without saving.

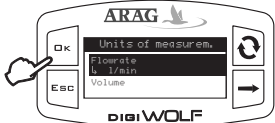

9.4.2 Units of measurement

Set units of measurement for flowrate values and volume read by the device.

9.4.2.1 Rate units of measurement

 <p>The image shows the ARAG DIGI WOLF device screen with the 'Units of measur em.' menu. The 'Flowrate' option is highlighted. The 'OK' key is indicated by a hand icon pointing to it.</p>	<p>Access instant rate units of measurement menu (Setup menu > Options > Units of measur em. > Flowrate).</p> <p>Under the selected item, the currently set value will be displayed.</p> <p>Press OK key to access flowrate units of measurement selection.</p>
 <p>The image shows the ARAG DIGI WOLF device screen with the 'Flowrate' menu. The 'l/min.' option is highlighted. The 'OK' key is indicated by a hand icon with the number '2' pointing to it. The 'ESC' key is also indicated by a hand icon with the number '2' pointing to it. The 'Flowrate' menu also shows 'GPM' and 'm³/h' options.</p>	<ol style="list-style-type: none"> 1) Select measurement unit using  key. 2) Press OK key to save, or ESC to exit without saving.

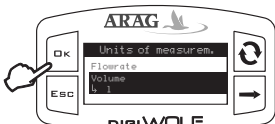
9.4.2.2 Volume units of measurement

 <p>The image shows the ARAG DIGI WOLF device screen with the 'Units of measur em.' menu. The 'Volume' option is highlighted. The 'OK' key is indicated by a hand icon pointing to it.</p>	<p>Access volume units of measurement menu (Setup menu > Options > Units of measur em. > Volume).</p> <p>Under the selected item, the currently set value will be displayed.</p> <p>Press OK key to access volume units of measurement selection.</p>
 <p>The image shows the ARAG DIGI WOLF device screen with the 'Volume' menu. The 'l' option is highlighted. The 'OK' key is indicated by a hand icon with the number '2' pointing to it. The 'ESC' key is also indicated by a hand icon with the number '2' pointing to it. The 'Volume' menu also shows 'gal' and 'm³' options.</p>	<ol style="list-style-type: none"> 1) Select measurement unit using  key. 2) Press OK key to save, or ESC to exit without saving.

9.5 Test

In this menu it is possible to see some information and run a device operation test:

- Firmware version:

The display shows the firmware version installed on the device.

- Sensor frequency:

In the presence of flow passage, the display shows in real time the frequency of the signal from the sensor reading the flowrate.

- Battery voltage:

the display shows the device supply voltage level.

9.5.1 Display test

Display test checks the correct operation of the display on the device.

	<p>Access display test menu (Setup menu > Test > Display test). Press OK key to access the test.</p>
	<p>The display shows all pixels on. Press ESC key to return to the previous screen.</p>

9.5.2 Keys test

Keys test checks the correct operation of the keys on the device.

	<p>Access keys test menu (Setup menu > Test > Keys test). Press OK key to access the test.</p>
	<ol style="list-style-type: none"> 1) Pressing one key, the corresponding portion of the display will light up. 2) To exit, press ESC key: after lighting up the corresponding portion of the display, it will return to the previous screen.

10 MAINTENANCE

10.1 Notes on maintenance

- At the end of each treatment, run clean water through the tubes.
- Clean the tank filling system pipe with a special detergent on a regular basis.
- Clean (and if necessary, replace) the flowmeter paddle on a regular basis (page 19, chap 10.2)



- **Do not use metal or abrasive objects to clean the paddle.**
- **Do not use solvents or fuel to clean the case outer surface.**

10.2 Paddle cleaning and replacement

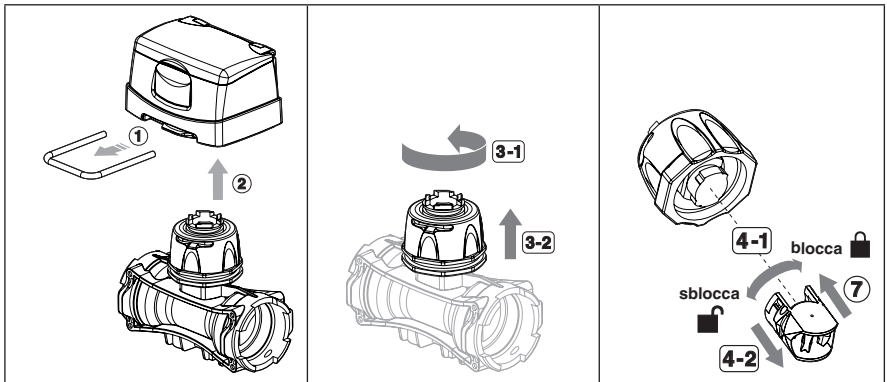

- 1) Remove the fork from the monitor using a screwdriver.
- 2) Remove the monitor from the flowmeter body.
- 3) Unscrew the ring nut in a counter clockwise direction and remove the sensor housing block from the flowmeter body.
- 4) With half a rotation, remove the paddle group from the sensor housing block in a counter clockwise direction.
- 5) Immerse the paddle group in detergent liquid for several hours.
- 6) Wash the paddle group thoroughly with running water and check its correct operation. If necessary, replace the complete paddle group with its suitable spare part (**code 4626000.500**).
- 7) Refit the paddle group on the electronic sensor with a clockwise rotation until it clicks in place.

CONTINUES

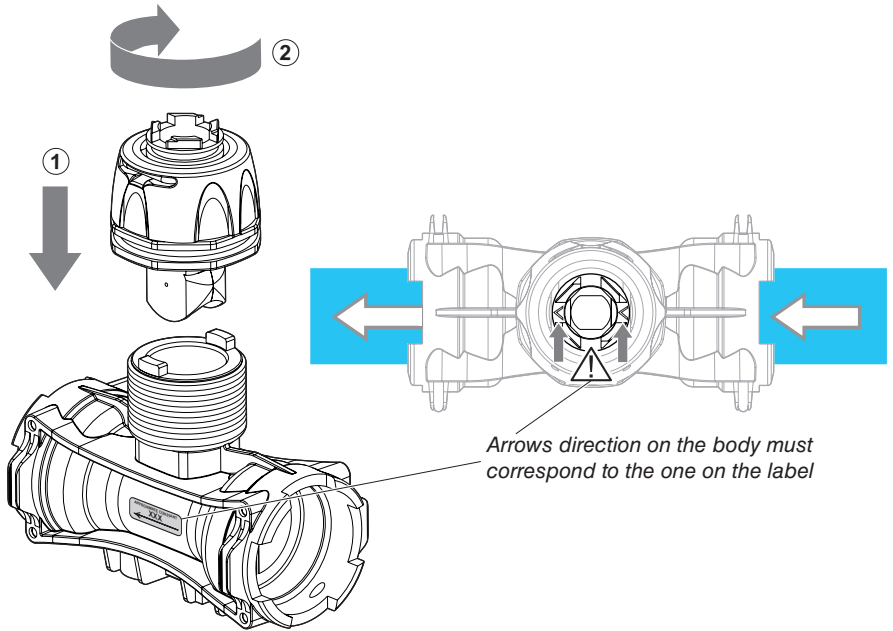

8) Refit the sensor housing block on the flowmeter body tightening the ring nut in a clockwise direction until it stops **paying attention to keep the arrow on the coupling facing the flow direction.**

10.3 OR replacement

With the removed sensor housing block (see Par. 10.2) proceed as follows:

	<p>1) Remove the fork from the ring nut using a screwdriver.</p>
	<p>2) Remove the ring nut.</p> <p>- OR replacement: Replace the ORs (Code G10051V - ARAG spare parts catalogue).</p> <p>3) Refit the sensor housing block ensuring that the fork is correctly inserted in the ring nut.</p>

10.4 Troubleshooting

FAULT	CAUSE	REMEDY
The valve leaks or the seal of the ball is not enough	Presence of foreign bodies	<ul style="list-style-type: none"> • Make sure there are no foreign bodies; if so, remove them.
	Worn seals	<ul style="list-style-type: none"> • Contact your nearest assistance centre.
The valve is not working and the display is off	Lack of power	<ul style="list-style-type: none"> • Check the connections, the cables, and the controls. Replace the cable. If the problem persists, contact your nearest service centre.
The valve does not work	Geared motor broken	<ul style="list-style-type: none"> • Replace the geared motor. The instructions can be found on our Website www.aragnet.com - ADDIN D30025.
The valve does not stop at the preset point	Malfunction of the microswitches in the geared motor	<ul style="list-style-type: none"> • Contact your nearest assistance centre.
Totalizers do not progress during the passage of liquid.	Rate is beyond operation limits of the flowmeter	<ul style="list-style-type: none"> • The model of the flowmeter is not adequate for the flowrate to be measured. Replace the flowmeter.
	The paddle-wheel is locked	<ul style="list-style-type: none"> • Clean or replace the paddle-wheel group if necessary.
Displayed flowrate is not stable	Presence of turbulence or air in the circuit	<ul style="list-style-type: none"> • Check the circuit.
	Worn paddle	<ul style="list-style-type: none"> • Replace the paddle.

TECHNICAL DATA

11 TECHNICAL DATA

	Data	Min.	Max.	Default	UoM	Notes
Calibration	Manual calibration	1	50,000	600	--	--
	Flowrate alarms					
	Min. flowrate alarm	0.1	99999.9	OFF	l/min.	The alarm can be deactivated setting the value "OFF"
	Max. flowrate alarm	0.1	999999.9	OFF	l/min.	The alarm can be deactivated setting the value "OFF"
Display	Brightness	0%	100%	50%	%	--
	Contrast	0%	100%	50%	%	--
Filling	Valve activation time	0.0	9.9	0.0	sec.	
	Filling quantity	0.1	99999.9	3000.0	litres	
Options	Language	-	-	English	-	Language settings: Italiano, English, Español, Português, Français, Deutsch, Cesky, Polski, 日本語, Русский, Magyar.
	Rate units of measurement	-	-	l/min.	-	Units of measurement settings: l/min, GPM, m ³ /h
	Volume units of measurement	-	-	litres	-	Units of measurement settings: l, gal, m ³

Description	Tank filling system
Power supply	12 Vdc ± 10%
Short circuit protection	•
Flowrate signal	square wave (0 ÷ V suppl.)
Max. frequency	1,2 KHz
Max. absorption	3 A
Working temperature	0 °C ÷ 60 °C +32 °F ÷ +140 °F
Storage temperature	-30 °C ÷ 80 °C / -22 °F ÷ +176 °F
Dimensions	330x200x346 mm
Weight	3500 g

Tab 2

12 DISPOSAL AT THE END OF SERVICE

Dispose of the system in compliance with the established legislation in the country of use.



INFORMATION TO USERS – PROFESSIONAL WEEE RECYCLING

This product complies with European Directive 2002/96/EC and subsequent modifications. At end-of-life and for disposal, the device must be taken to a waste recycling centre for electrical and electronic waste, or returned to the seller when buying a new equivalent device.

The user is responsible for its transfer to the appropriate collection facilities. For more detailed information concerning the collection systems available contact your local waste disposal service.

13 GUARANTEE TERMS

1. ARAG s.r.l. guarantees this apparatus for a period of 360 day (1 year) from the date of sale to the client user (date of the goods delivery note).
The components of the apparatus, that in the unappealable opinion of ARAG are faulty due to an original defect in the material or production process, will be repaired or replaced free of charge at the nearest Assistance Centre operating at the moment the request for intervention is made. The following costs are excluded:
 - disassembly and reassembly of the apparatus from the original system;
 - transport of the apparatus to the Assistance Centre.
2. The following are not covered by the guarantee:
 - damage caused by transport (scratches, dints and similar);
 - damage due to incorrect installation or to faults originating from insufficient or inadequate characteristics of the electrical system, or to alterations resulting from environmental, climatic or other conditions;
 - damage due to the use of unsuitable chemical products, for spraying, watering, weedkilling or any other crop treatment, that may damage the apparatus;
 - malfunctioning caused by negligence, mishandling, lack of know how, repairs or modifications carried out by unauthorised personnel;
 - incorrect installation and regulation;
 - damage or malfunction caused by the lack of ordinary maintenance, such as cleaning of filters, nozzles, etc.;
 - anything that can be considered to be normal wear and tear.
3. Repairing the apparatus will be carried out within time limits compatible with the organisational needs of the Assistance Centre.
No guarantee conditions will be recognised for those units or components that have not been previously washed and cleaned to remove residue of the products used.
4. Repairs carried out under guarantee are guaranteed for one year (360 days) from the replacement or repair date.
5. ARAG will not recognise any further expressed or intended guarantees, apart from those listed here.
No representative or retailer is authorised to take on any other responsibility relative to ARAG products.
The period of the guarantees recognised by law, including the commercial guarantees and allowances for special purposes are limited, in length of time, to the validities given here. In no case will ARAG recognise loss of profits, either direct, indirect, special or subsequent to any damage.
6. The parts replaced under guarantee remain the property of ARAG.
7. All safety information present in the sales documents regarding limits in use, performance and product characteristics must be transferred to the end user as a responsibility of the purchaser.
8. Any controversy must be presented to the Reggio Emilia Law Court.

14 CONFORMITY DECLARATION

The declaration of conformity is available at www.aragnet.com, in the relevant section.

Only use genuine ARAG accessories or spare parts to make sure manufacturer guaranteed safety conditions are maintained in time. Always refer to the internet address www.aragnet.com

09/2012

D20261-m00

ARAG®

A Nordson Company

42048 RUBIERA (Reggio Emilia) - ITALY
Via Palladio, 5/A

Tel. +39 0522 622011

Fax +39 0522 628944

<http://www.aragnet.com>

info@aragnet.com