

**ELECTRIC BALL VALVE
- GEAR MOTOR WITH POSITION INDICATOR**

CE

853 SERIES

INSTALLATION, USE AND MAINTENANCE

CONTENTS



1	Technical data	3
2	Images	4
3	Field of application	6
4	Limitations of use	6
5	Safety Regulations	6
6	Maximum operating pressure	7
6.1	Overall dimensions.....	7
7	Installation	7
7.1	Geared motor rotation	7
7.2	Attachment.....	7
7.3	Types of bolts.....	8
7.4	Drilling template	8
7.5	Hydraulic connections.....	8
7.6	Wiring connections.....	8
7.7	Position indicator.....	8
7.8	Position and power supply LED	8
8	Use	9
9	Maintenance	9
10	Troubleshooting	9
11	Disposal	9
12	Warranty	9
13	Conformity Declaration	9

LEGEND SYMBOLS

 = Generic danger

 = Warning

1 TECHNICAL DATA

WAYS	CODE	Op. time 	@ 12 Vdc	UHMW BALL  mm R	AISI 316 BALL  mm T	Coupling M (1 - 1 - 1)					Tightening torque																			
						F	1	2	3	4	5	(1 - 1 - 1)																		
							mm	mm	mm	mm	mm	A	B	C	X	Y	Nm	inch/lb												
2-3	853Rx 4xxx 853Tx 4xxx 853Rx 4xxxJ 853Tx 4xxxJ	1.4 sec. (3 way bottom connection only; 2.8 sec)	3 A	32	T5	-	-	34	-	-	81	42	186	33	38	5	44													
	T6				-	-	42	-	-																					
	1"				10	-	-	-	25																					
	1" 1/4				12	-	-	-	-																					
	1" 1/2				12,5	25	-	49,5	20																					
	853Rx 5xxx 853Tx 5xxx	2.3 sec. (3 way bottom connection only; 4.6 sec)		40	T7	-	-	43	-	-	93	52	192	40	49	4	36													
	853Rx 6xxx 853Tx 6xxx 853Rx 6xxxJ 853Tx 6xxxJ			50	2"	16	28	-	55	26								118	61	210	57	60	5	44						
	853Rx 7xxx 853Tx 7xxx			65	2" 1/2	16	35	-	-	-																				
				3"	19	38	-	59	28	136															71	223	72	80	4	36
				T9	-	-	49	-	-																					

Tab. 1

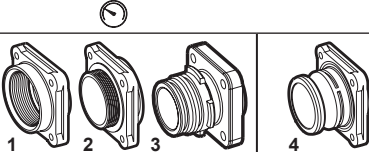
WAYS	COUPLING				
		1	2	3	4
2-3	T6	12 bar / 180 PSI			9 bar / 130 PSI
	1"				
	1" 1/4				
	1" 1/2	10 bar / 150 PSI			
	2"	8 bar / 120 PSI			8 bar / 120 PSI
	T7				
	2" 1/2	6 bar / 90 PSI			---
3"				5 bar / 75 PSI	

Tab. 2

	
1" Flange	10 bar / 150 PSI
2" Flange	10 bar / 150 PSI
2" Flange full port	8 bar / 120 PSI
2" Flange full port	6 bar / 90 PSI
3" Flange	

Tab. 3



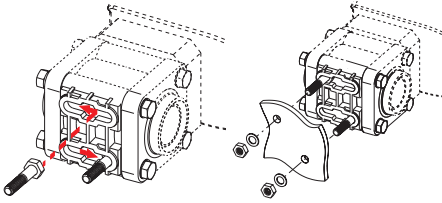

Fig. I

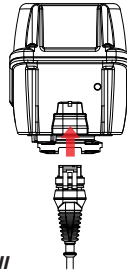

Fig. II



2 ways

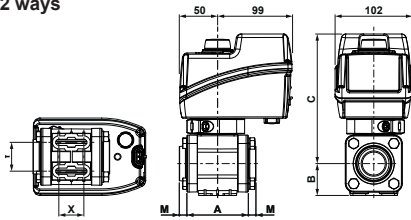

Fig. III

**3 ways
side connection**

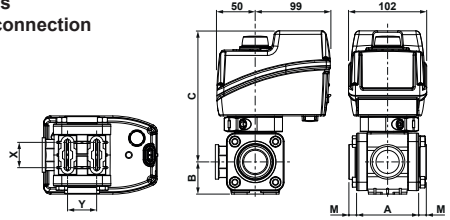

Fig. IV

**3 ways
bottom connection**

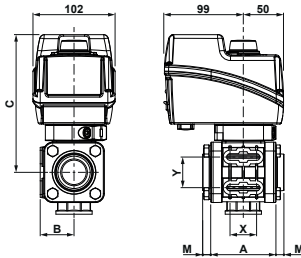

Fig. V

***Not present on all models**

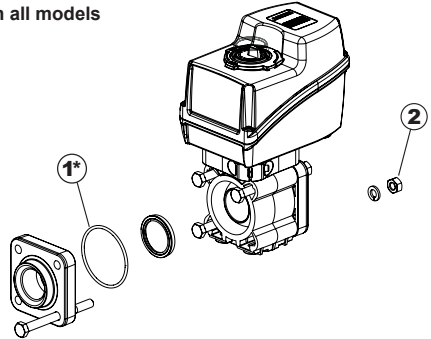

Fig. VI

3 wire connection

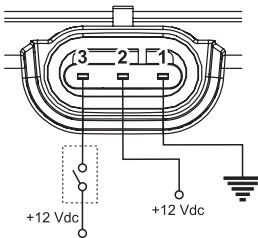

Fig. VII

2 wire connection

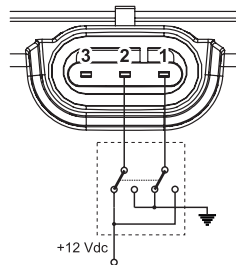
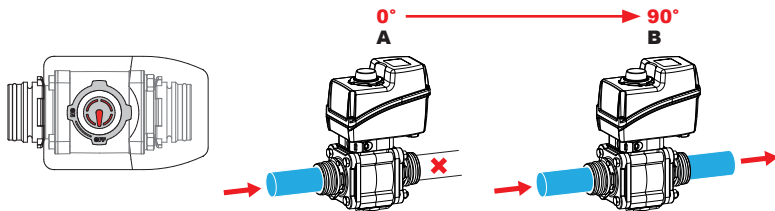
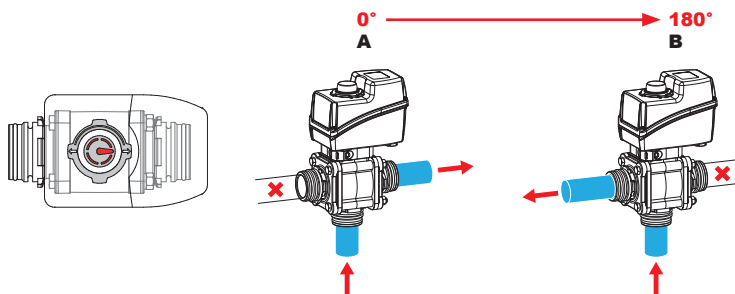

Fig. VIII

2 ways



3 ways - bottom connection



3 ways - side connection J

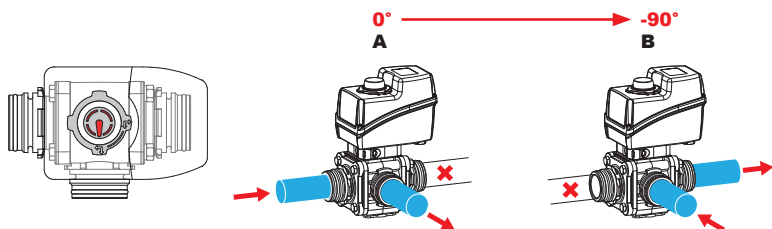

3 ways - side connection

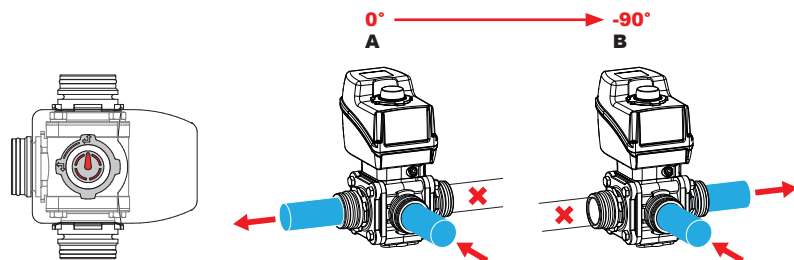

3 FIELD OF APPLICATION

The 853 series electric valves are designed for use in the agricultural sector and can be used as flow switches in a system under pressure for conveying liquids.

These valves are for professional use only.

4 LIMITATIONS OF USE

The 853 series electric valves may not be used:

- as safety valves;
- in systems where gases, vapors, or similar pass through;
- in systems for explosive atmospheres;
- in contact with foodstuff;
- in civil systems.



This device is designed to work on agricultural machinery for spraying and crop spraying applications.

The equipment is designed and manufactured according to:

- Directive 2014/30/UE and following amendments (EN ISO 14982 - Electromagnetic Compatibility - agricultural and forest machines);
- Directive 2006/42/EC and following amendments.

5 SAFETY REGULATIONS



CAUTION: All installation and maintenance operations must be carried out by qualified personnel with circuit not under pressure and without power supply (connector disconnected).



ARAG IS NOT LIABLE FOR ANY DAMAGE RESULTING FROM INSTALLATION BY UNSKILLED PERSONNEL. ANY SYSTEM DAMAGE CAUSED BY A WRONG INSTALLATION AND/OR CONNECTION AUTOMATICALLY VOIDS THE WARRANTY.

CARRYING OUT INSTALLATION AND MAINTENANCE OPERATIONS WITHOUT DISCONNECTING THE VALVE FROM ITS POWER SUPPLY MAY CAUSE SEVERE INJURY.

Do not operate the valve with no load for long periods of time, as this might damage the components inside the valve.

ARAG declines any responsibility for direct or indirect damage deriving from the type of fluids used in the system.

The use of such substances is made under the full responsibility of the operator, who therefore must follow the safety measures indicated by the fluid manufacturer on the package and wear suitable personal safety equipment (gloves, coverall, boots, helmet, etc.) in compliance with the law provisions.

ARAG may not in any way be held responsible for accidents or damage to persons, animals or things caused by improper, unprotected, or non-recommended use of the products utilized.

6 MAXIMUM OPERATING PRESSURE

The maximum operating pressure of the valve depends on the type of coupling it is fitted with (**Tab. 2 - Tab. 3**).

E.g.: If the valve has different couplings, for instance two threaded couplings and one camlock, the maximum operating pressure will be equal to the maximum pressure permitted by the coupling with lower pressure.

Mod. 85372 4A44 Female = 12 bar

Mod. 85372 4D44 Female-Camlock = 10 bar

6.1 Overall dimensions

Refer to **Tab. 1** and **Fig. III - Fig. IV - Fig. V**.

7 INSTALLATION

Installation must be carried out by specialized personnel. ARAG may not be held responsible for damage to persons, animals or things caused by installation carried out by unqualified personnel.

- The components, pipes and valves that will be installed in the system must withstand a pressure higher than the maximum one of the system.
- Any constriction in the system may lead to a faulty over-pressure.
- Make sure that hoses, hose tails and valve flanges feature a suitable and compatible diameter.



CAUTION: connect the power supply connector to the valve only after having completed the hydraulic connections.

OPERATING THE VALVE WITH ONE OR MORE INLETS/OUTLETS OPEN IS VERY DANGEROUS AND CAN CAUSE ACCIDENTS AND SERIOUS INJURIES TO THE INSTALLATION OR MAINTENANCE PERSONNEL.



DO NOT INSERT ANY FOREIGN BODIES OR YOUR HANDS INTO THE HOLE OF THE BALL WHILE THE VALVE IS CONNECTED TO THE ELECTRIC POWER SUPPLY, AS THIS COULD LEAD TO CRUSHING OR AMPUTATION.



CAUTION: TO AVOID DAMAGING THE SYSTEM, MAKE SURE THAT NONE OF THE PARTS COMES INTO CONTACT WITH MOVING PARTS OF THE FARMING MACHINE.

7.1 Geared motor rotation

The geared motor of the 853 valves can be turned in 90°-steps to set it in the most suitable position according to the system the valves are installed in.

Turning the geared motor is a simple but delicate operation, which may impair valve operation or lead to system errors and/or accidents if performed in the wrong way.

It is therefore very important to perform this operation by thoroughly observing the instructions provided in document D30058, that is available for download in the website www.aragnet.com/download.



ARAG will not be held responsible for any damage to the system, people, animals or things caused by modifications to the ball valve and/or failure to follow the guidelines outlined in the mentioned documents.

7.2 Attachment

The ball valve is factory set to be attached using bolts (**Fig. I**) of the type indicated in section 7.3.

- Insert the bolts into their respective seats and turn them to the stop position to prevent them from coming out.

On valves with 1" ½ or larger coupling, we recommend also using a flat washer of suitable diameter (Ø 8 ISO 7089). - Insert the bolts into the holes provided (refer to section "7.4 Drilling template"), then tighten the nuts thoroughly.



No other types of coupling are permitted than those described.

7.3 Types of bolts

To attach the valve use bolts of the following types:

- M8 ISO 4014/4017
- 5/16" ANSI B18.2

With coupling greater than 1" ½:

- M8 ISO 4014/4017 + M8 ISO 7089 washer
- M8 ISO 4162 / • 5/16" ANSI B18.2

7.4 Drilling template

Refer to **Tab. 1** for the position of the drilling points for the attachment bolts.

7.5 Hydraulic connections

Remove the protective caps and connect the inlet/outlet hoses to the valve, using the correct connections for which it is set. Take special care, where requested, to insert the supplied O-ring correctly (threaded ends). If, for any reason, the pipes leak at connection points, apply unsintered PTFE tape to improve sealing.



CAUTION: For the maximum operating pressure for the chosen connection, refer to Tab. 2 - Tab. 3.

Once all the couplings of the valve are connected, put the system under pressure **ONLY WITH CLEAN WATER** first to make sure that the connections are not leaking.

7.6 Wiring connections

The valve must be powered by means of the connector fixed to the geared motor.

To connect the valve, use suitable cables available on the Arag catalog.

Connect the gearmotor connector to that of the relevant harness; after making sure it is correctly inserted, press until it is locked - **Fig. II**

3-wire operation - Fig. VII	2-wire operation - Fig. VIII
<ul style="list-style-type: none">• 12 Vdc power supply, always connected• With opening/closing command supplied with 12 Vdc, the valve turns clockwise.• Disconnecting the command power supply, the valve turns counter-clockwise.	<ul style="list-style-type: none">• Rotation obtained by inverting the power supply polarity with a double switch.

7.7 Position indicator

The external position indicator allows viewing the orientation of the ball inside the valve, thus identifying the opening/closing status (2 ways) or the fluid direction (3 ways).

7.8 Position and power supply LED

The LED indicates power supply status, correct power supply polarity and position of the ball inside the valve.

To correctly read the table refer to the reference figures on page 5

3-wire operation		
COLOR LED LIGHT	BALL POSITION (see page 5)	STATUS AND POLARITY POWER SUPPLY
Red	A	Correct
Yellow	B	Correct
Off	--	No power supply or reversed polarity

2-wire operation		
COLOR LED LIGHT	BALL POSITION (see page 5)	POWER SUPPLY
Red	A	Correct
Yellow	B	Correct
Off	--	Absent

8 USE

Power the valve using a suitable control device (refer to **Tab. 1** for the exact absorption values).



CAUTION: Do not run light valve for a long time, the inside gaskets could be damaged and the valve could block up.

9 MAINTENANCE

The electric ball valves of the 853 series do not require any particular maintenance.

Internal cleaning can be carried out when the system to which the valve is connected is cleaned. If the maintenance man needs to open the valve to check the seal or for extraordinary cleaning, before fitting it back you must replace the seal kit of the orifice that was opened.



CAUTION: Fitting back the valve without replacing the seal kit can reduce the seal on the internal ball and therefore cause leaks.

- Unscrew the bolts related to the orifice to be opened, then remove it and take out the inner gaskets and the O-ring inserted in the internal seat of the flange that has been removed.
- Re-position all the gaskets in their seats, as shown in **Fig. VI** (gasket **(1)** is not present on all models), then close the flange.
- Insert the bolts in the holes, fit back the washers and screw in the nuts by hand.
- To ensure correct operation, the nuts **(2)** must be tightened using a dynamometric spanner calibrated according to that which is indicated in **Tab. 1**.
- Reconnect all the hydraulic connections.
- Restore electric power supply.
- Put the system under pressure ONLY WITH CLEAN WATER and check that the connections are not leaking.

Further information on the special maintenance operations can be downloaded free of charge from our website www.aragnet.com.

10 TROUBLESHOOTING

FAULT	CAUSE	REMEDY
The valve leaks or the seal of the ball is not enough	Presence of foreign bodies	• Make sure there are no foreign bodies; if so, remove them.
	Worn seals	• Replace the seals.
The valve does not work	Lack of power	• Check the connections and the cables. Replace the cable. If the problem persists, contact your nearest Service Centre.
	The harnesses are not connected correctly	• Check the connections and the cables.
	Power supply voltage is lower than the minimum value	• Make sure that the harnesses are suitable for the system
	Geared motor broken	• Replace the geared motor.
The valve does not stop at the preset point	Geared motor broken	• Replace the geared motor.

11 DISPOSAL

Dispose of the system in compliance with the established legislation in the country of use.

12 WARRANTY

The product is guaranteed for a period of 12 months from the purchase date. Complete information on the warranty is provided in the ARAG general catalogue and on our Website at the address www.aragnet.com.

13 CONFORMITY DECLARATION

The declaration of conformity is available at www.aragnet.com, in the relevant section.

*Only use original ARAG accessories and spare parts, to maintain safety conditions foreseen by the constructor.
Always refer to the ARAG spare parts catalogue.*

*This manual is an integral part of the equipment to which it refers and must accompany the equipment in case of sale or change of ownership.
Keep it for future reference; ARAG reserves the right to modify the specifications and instructions regarding the product at any time and without prior notice.*

ARAG[®]

A Nordson Company

42048 RUBIERA (Reggio Emilia) - ITALY
Via Palladio, 5/A

Tel. +39 0522 622011
Fax +39 0522 628944

www.aragnet.com
info@aragnet.com