

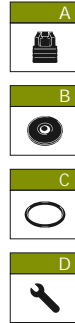

AR 50

32097 AR 50 SP - BlueFlex

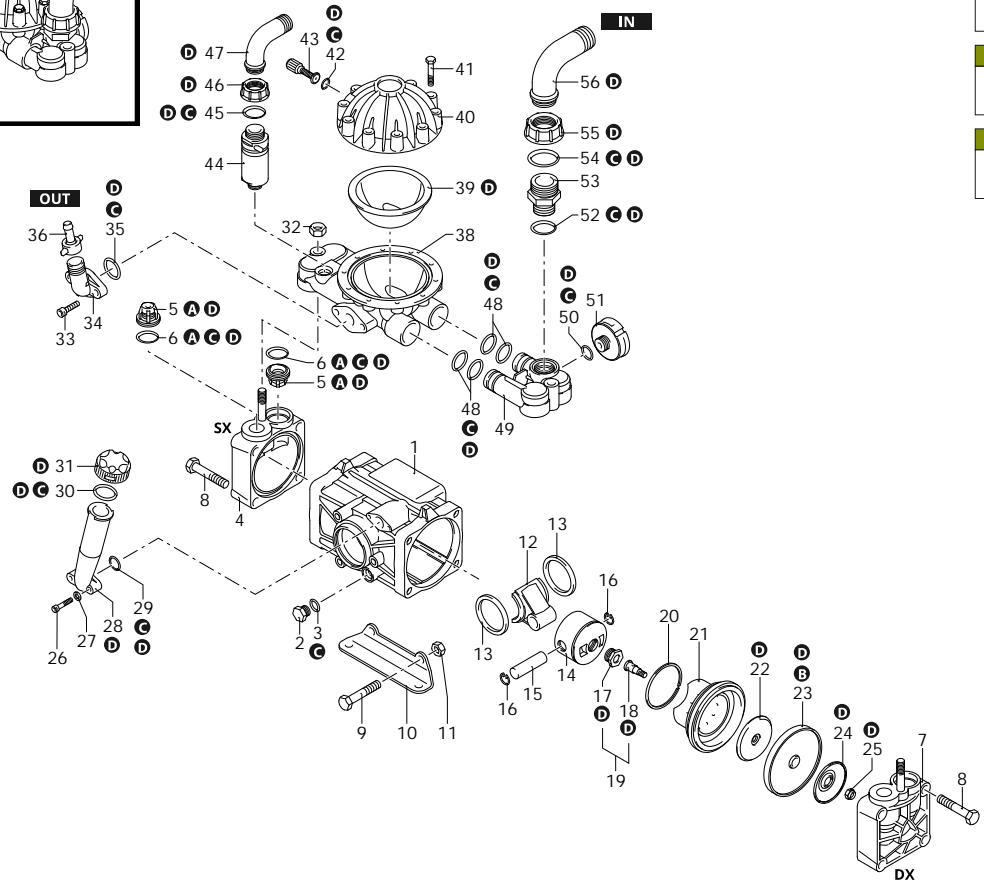
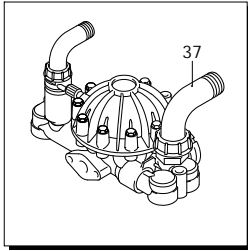

Code	Description	Q	Note	Validity
1	650011 Pump body		1	
2	880530 Plug	3/8" G	1 C=20Nm	
3	740290 O-ring	Ø 14x1,78	1 Lubricate Molykote PG54	
4	650102 Head	sx	1	
5	659050 Valve		4	
6	320030 O-ring	Ø 31,5x4,5	4 Lubricate with Mineral Grease	
7	650101 Head	dx	1	
8	750060 Screw	TE M12x65	8 C=50Nm	
9	750060 Screw	TE M12x65	2 C=50Nm	
10	320392 Foot		2	
11	320130 Nut	M12	2	
12	650142 Connecting-rod		2	
13	650130 Ring	Connecting-rod	4 Lubricate with motor oil	
14	650121 Piston	Ø 63	2	
15	650071 Pin		2 Lubricate with motor oil	
16	160691 Ring	seeger Øi 18	4	
17	650061 Bushing		2 C=30Nm	
18	650320 Hub pin		2	
19	659080 Bushing	complete	2	
20	650190 Piston ring		2	
21	650111 Sleeve		2	
22	650090 Plate		2	
23	650080 Diaphragm	BlueFlex - Øe 111	2	
24	650390 Plate		2	
25	160311 Nut	M8	2 C=20Nm / Molykote 1000	
26	850850 Screw	TCEI M6x30	2 C=10Nm	
27	550331 Washer		2	
28	650030 Tank		1	
29	180101 O-ring	Ø 17,5x2	1 Lubricate with motor oil	
30	550040 O-ring	Ø 26,65x2,62	1 Lubricate with motor oil	
31	550050 Plug	yellow	1	
32	320130 Nut	M12	2	
33	540290 Screw	TCEI M8x25	2 C=23Nm	
34	450145 Flange		1	
35	550350 O-ring	Ø 23,81x2,62	1 Lubricate with Mineral Grease	
36	110130 Ring nut	1/2" G	1	
37	43518 Air chamber	BlueFlex	1	
38	650180 Semi air chamber	lower	1	
39	650523 Diaphragm	BlueFlex - Øe 115	1	
40	650230 Semi air chamber	upper	1	
41	621780 Screw	TE M8x40	10 C=10Nm / Molykote 1000	
42	650542 Gasket		1 Lubricate with motor oil	
43	180020 Air valve		1 C=3Nm / Loxeal 55-14	
44	1609001 Safety valve	40 bar	1 C=10Nm / Loxeal 24-18	
45	880831 O-ring	Ø 15,54x2,62 Viton	1 Lubricate Molykote G-807	
46	550450 Ring nut	3/4" G	1	

AR_01_087_v01

Customer: AR
Customer Code:



SAE 30
1,000 Kg

Revision: 1

Date: 05/07/2024

Validity: < XX/YY = From week/year



AR 50

32097 AR 50 SP - BlueFlex

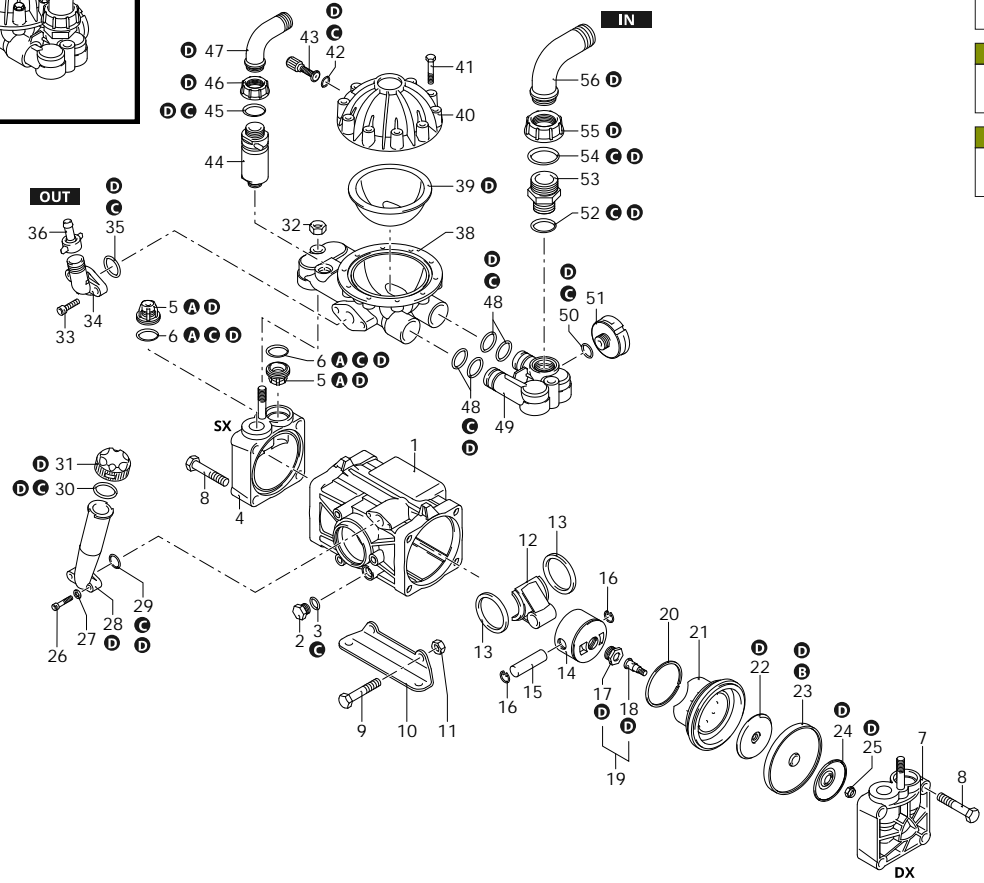
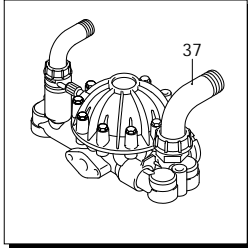

Code	Description	Ø	Q	Note	Validity
47	550460 Elbow	Ø 18	1		
48	550040 O-ring	Ø 26,65x2,62	4	Lubricate with motor oil	
49	650150 Fitting		1		
50	180101 O-ring	Ø 17,5x2	1	Lubricate with motor oil	
51	659213 Diaphragm		1		
52	390290 O-ring	Ø 29x3	1	Lubricate Molykote PG54	
53	450120 Fitting	1" G - 1"1/4" G (M-M)	1		
54	390290 O-ring	Ø 29x3	1	Lubricate Molykote PG54	
55	550870 Ring nut	1"1/4 G	1		
56	580040 Elbow	Ø 30	1		
A	1920 Valve kit		1		
B	43200 Diaphragms kit	BlueFlex	1		
C	1919 O-ring kit		1		
D	47491 Maintenance repair kit	BlueFlex	1		

AR_01_087_v01

Customer: AR
Customer Code:



Revision: 1
Date: 05/07/2024

Validity: < XX/YY = From week/year



AR 50

32097 AR 50 SP - BlueFlex

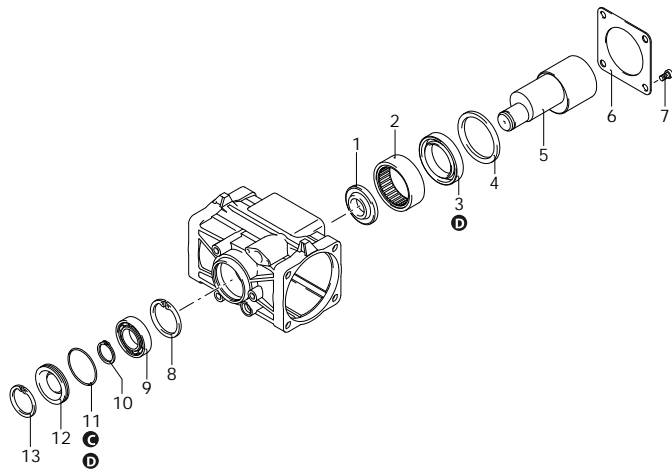
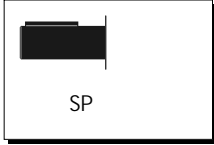

Code	Description	Q	Note	Validity
1	650160 Spacer	1		
2	650200 Bearing	1	Press Mount	
3	1400150 Ring	1	seal Lubricate with Mineral Grease	
4	1400110 Ring	1		
5	650170 Shaft	1	S marked	
6	1400140 Flange	1		
7	820670 Screw	4	TCEI M10x16 C=10Nm	
8	161050 Ring	1	seeger Øi 72	
9	230330 Bearing	1		
10	650480 Ring	1	seeger Øe 30	
11	650920 O-ring	1	Ø 53,65x2,62 Lubricate with Mineral Grease	
12	650040 Cover	1	Lubricate with motor oil	
13	200390 Ring	1	seeger Øi 62	
A	1920 Valve kit	1		
B	43200 Diaphragms kit	1	BlueFlex	
C	1919 O-ring kit	1		
D	47491 Maintenance repair kit	1	BlueFlex	

AR_03_092_v01

Customer: AR
Customer Code:



SAE 30
1,000 Kg

Revision: 1

Date: 05/07/2024

Validity: < XX/YY = From week/year